

GE 140 E FLURO

Spherical plain bearings

TYPE: Plain bearings, Spherical plain bearings and rod ends, Radial spherical plain bearings, Requiring maintenance, Series GE..E (FLURO)

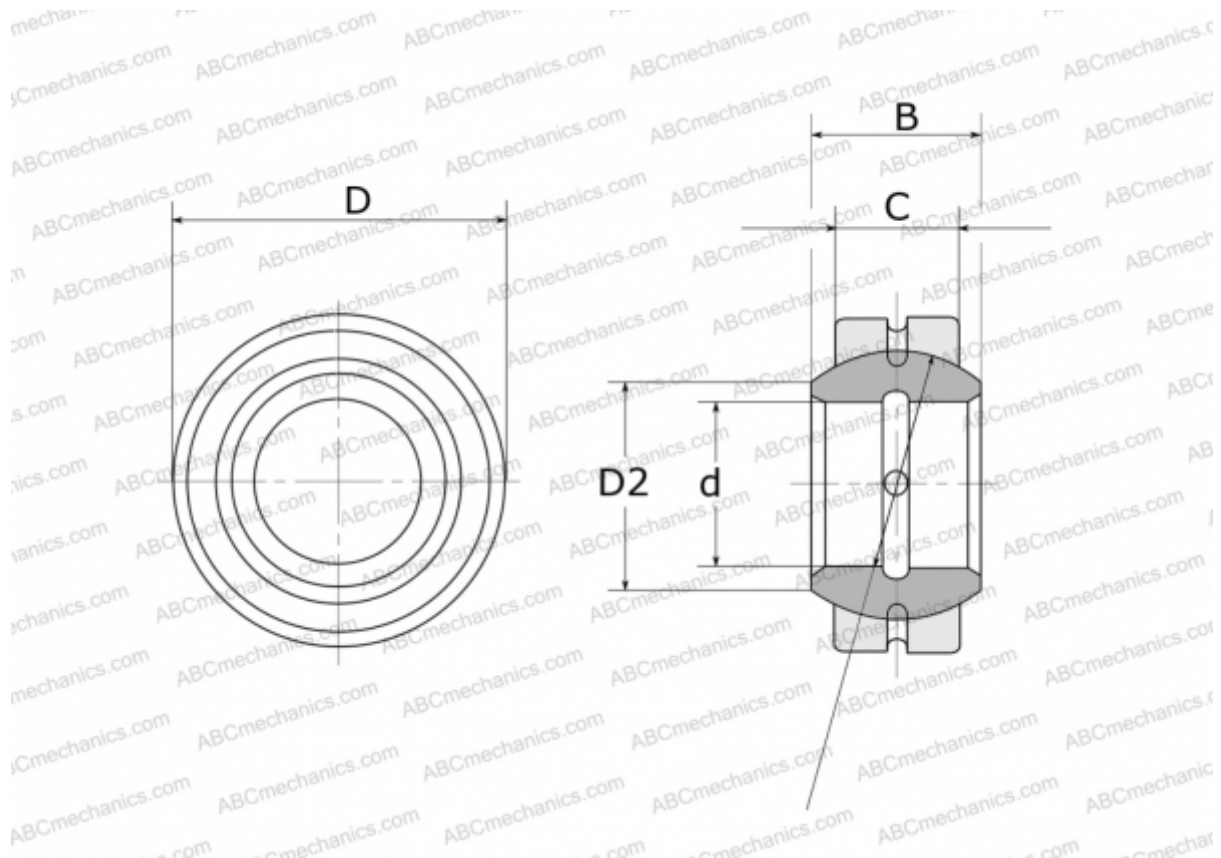

Technical specification

DIMENSIONS, MM

d	140,000
D	210,000
D2	155,800
B	90,000
f	180,000
C	70,000

WEIGHT, KG 11,200

MANUFACTURER [FLURO](#)