

## GE 100 E-2RS FLURO

Spherical plain bearings

TYPE: Plain bearings, Spherical plain bearings and rod ends, Radial spherical plain bearings, Requiring maintenance, Series GE..E-2RS (FLURO)

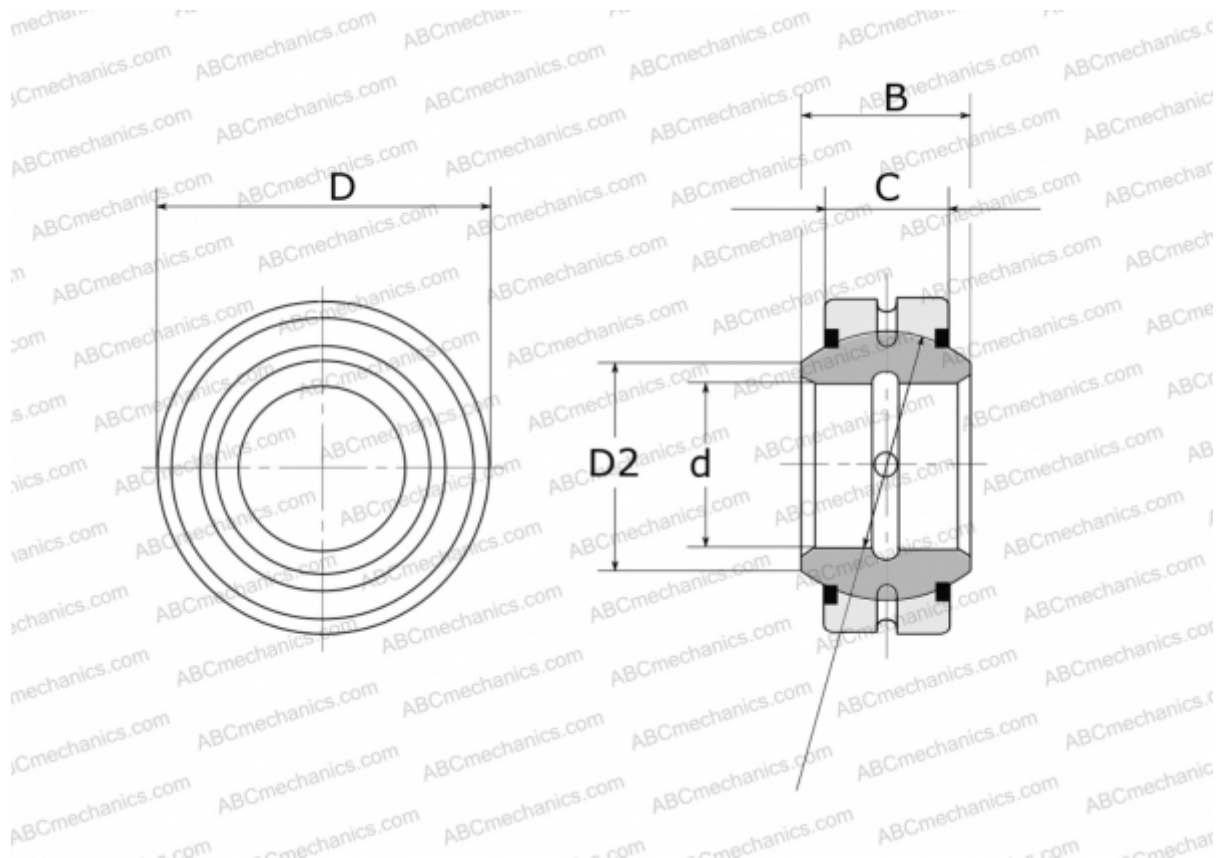

### Technical specification

#### DIMENSIONS, MM

d	100,000
D	150,000
D2	109,500
B	70,000
f	130,000
C	55,000

**WEIGHT, KG** 4,440

**MANUFACTURER** [FLURO](#)