

GE 30 HO-2RS FLURO

Spherical plain bearings

TYPE: Plain bearings, Spherical plain bearings and rod ends, Radial spherical plain bearings, Requiring maintenance, Series GE..-HO-2RS (FLURO), contact seals on both side

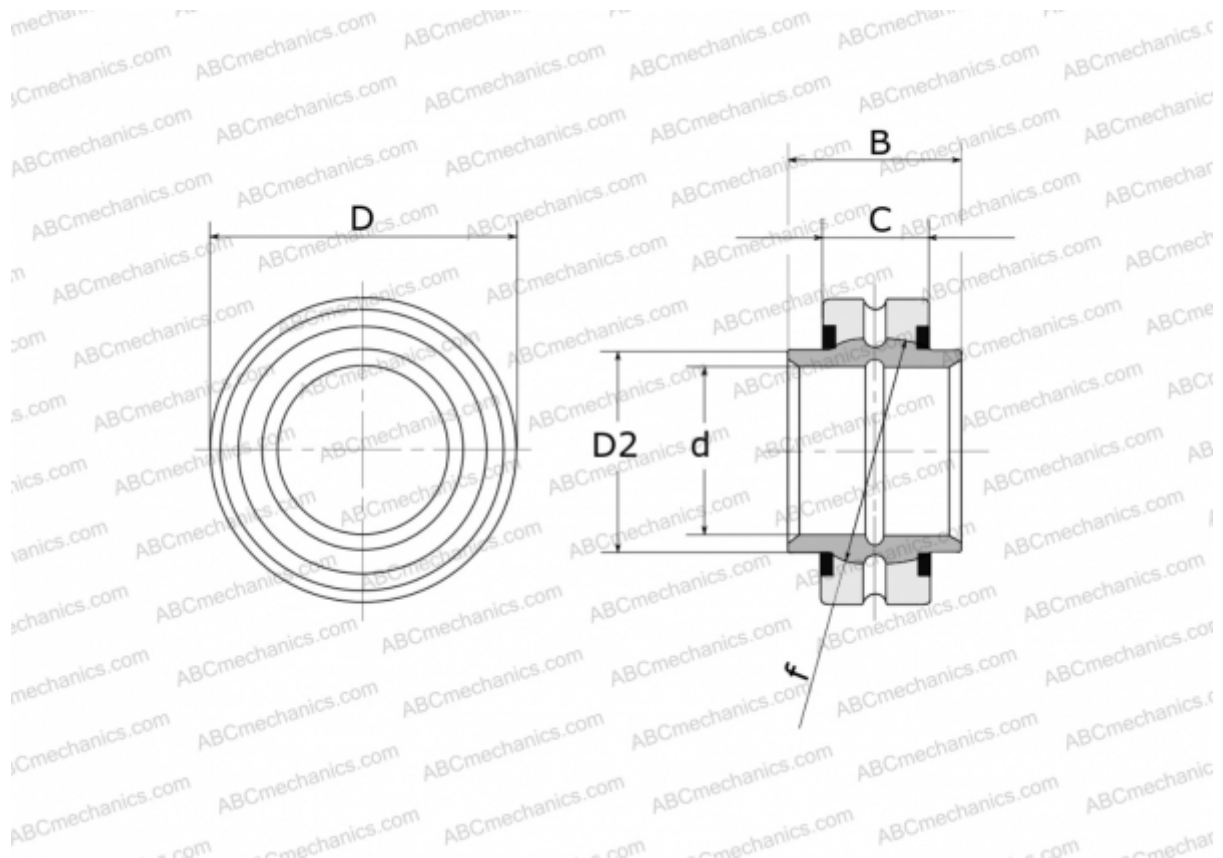

Technical specification

DIMENSIONS, MM

d	30,000
D	47,000
D2	34,200
B	30,000
f	40,700
C	18,000

MANUFACTURER [FLURO](#)