

GE 17 LO FLURO

Spherical plain bearings

TYPE: Plain bearings, Spherical plain bearings and rod ends, Radial spherical plain bearings, Requiring maintenance, Series GE...LO (FLURO)

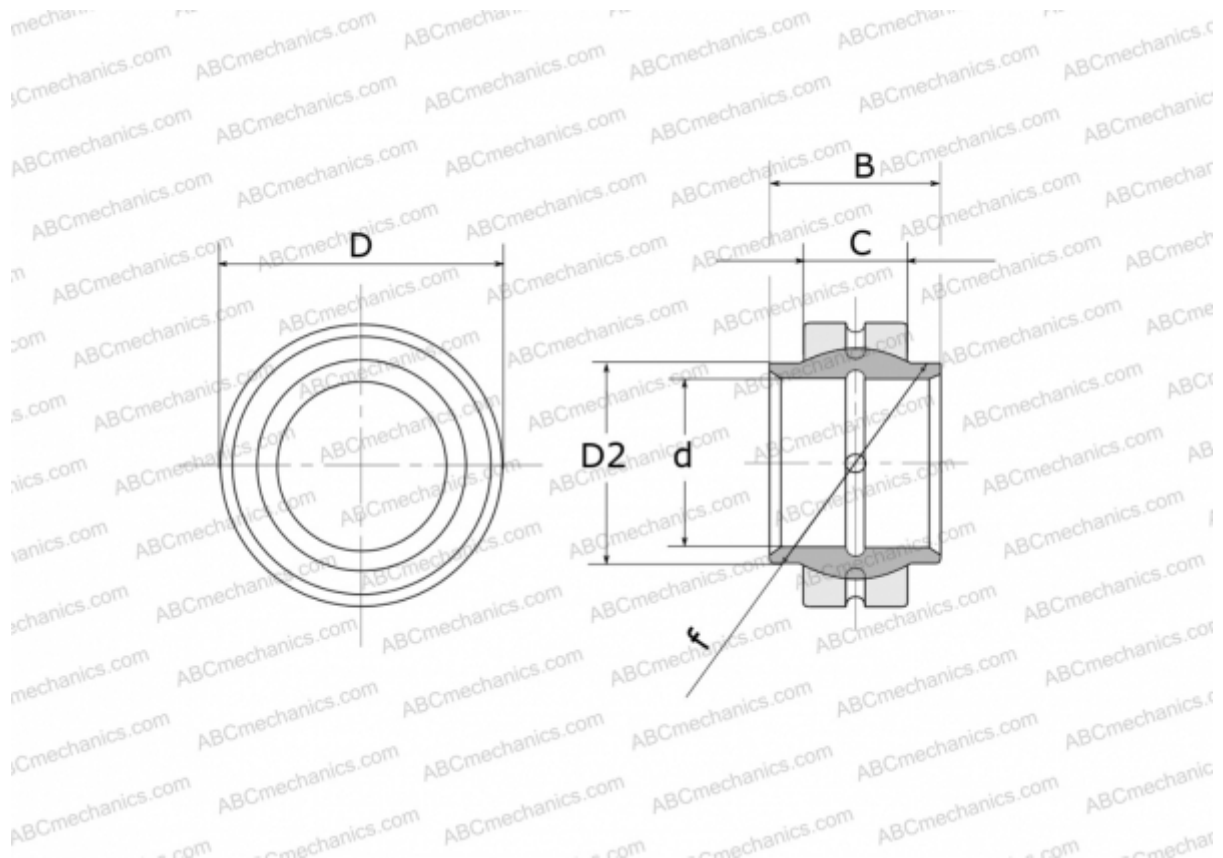

Technical specification

DIMENSIONS, MM

d	17,000
D	30,000
D2	21,000
B	17,000
f	25,000
C	10,000

WEIGHT, KG 0,043

MANUFACTURER [FLURO](#)