

GE 20 LO FLURO

Spherical plain bearings

TYPE: Plain bearings, Spherical plain bearings and rod ends, Radial spherical plain bearings, Requiring maintenance, Series GE...LO (FLURO)

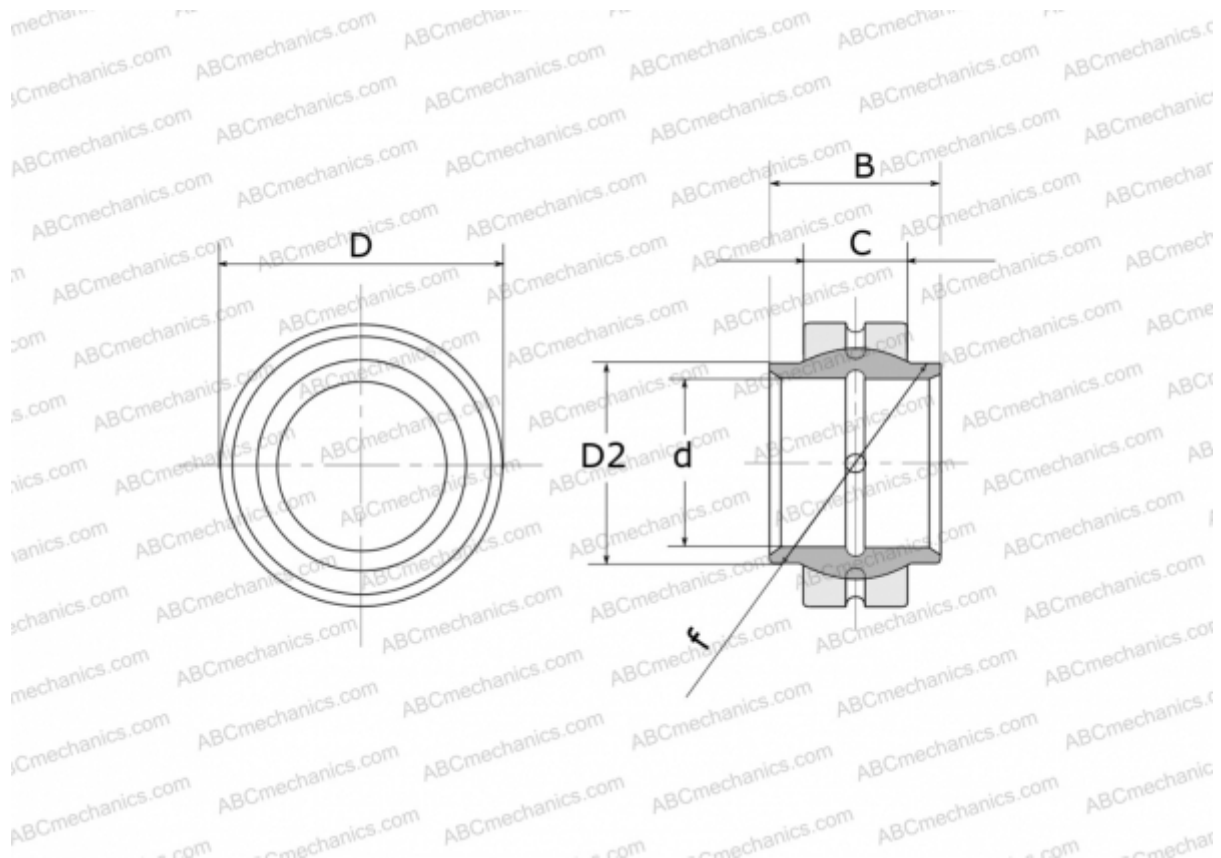

Technical specification

DIMENSIONS, MM

d	20,000
D	35,000
D2	25,000
B	20,000
f	29,000
C	12,000

WEIGHT, KG 0,069

MANUFACTURER [FLURO](#)