

GE 50 LO FLURO

Spherical plain bearings

TYPE: Plain bearings, Spherical plain bearings and rod ends, Radial spherical plain bearings, Requiring maintenance, Series GE...LO (FLURO)

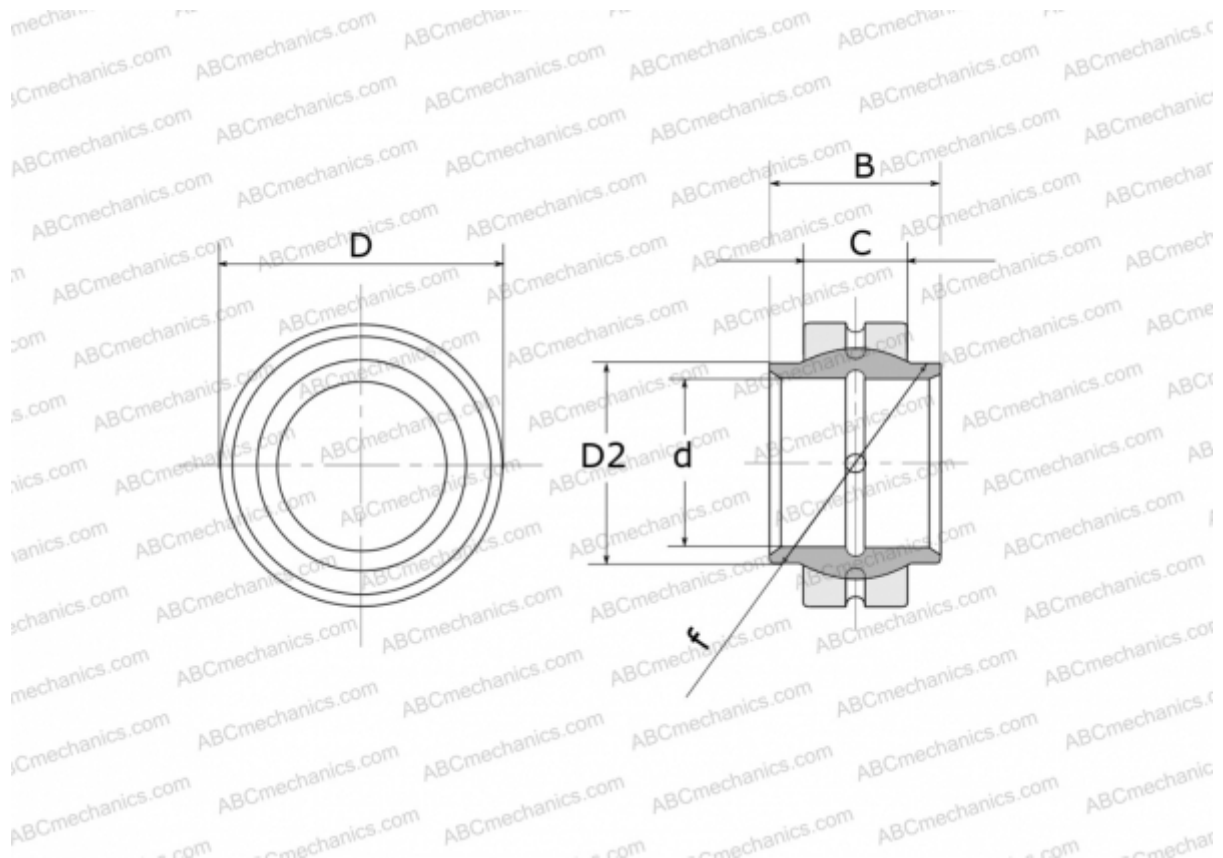

Technical specification

DIMENSIONS, MM

d	50,000
D	75,000
D2	57,000
B	50,000
f	66,000
C	28,000

WEIGHT, KG 0,620

MANUFACTURER [FLURO](#)