

GE 60 LO FLURO

Spherical plain bearings

TYPE: Plain bearings, Spherical plain bearings and rod ends, Radial spherical plain bearings, Requiring maintenance, Series GE...LO (FLURO)

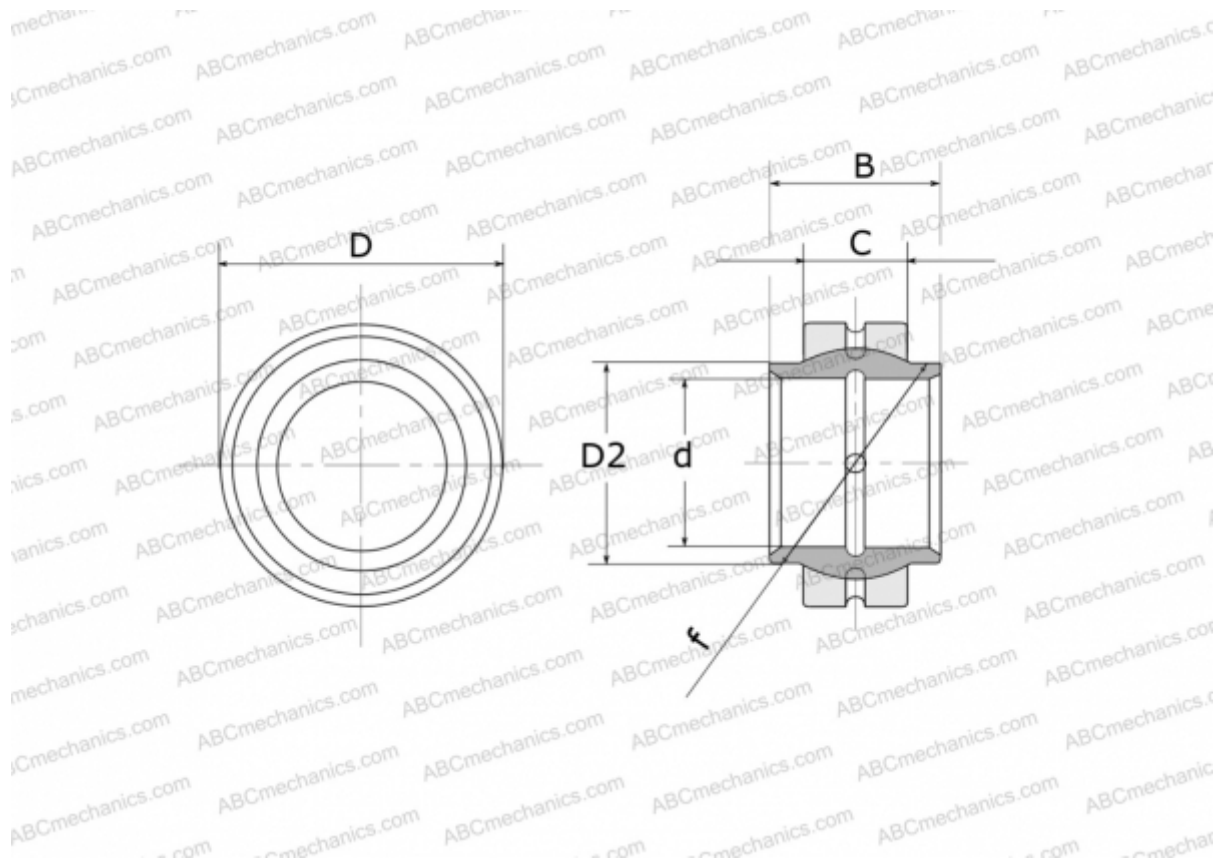

Technical specification

DIMENSIONS, MM

d	60,000
D	90,000
D2	68,000
B	60,000
f	80,000
C	36,000

WEIGHT, KG 1,110

MANUFACTURER [FLURO](#)