

GE 80 LO FLURO

Spherical plain bearings

TYPE: Plain bearings, Spherical plain bearings and rod ends, Radial spherical plain bearings, Requiring maintenance, Series GE...LO (FLURO)

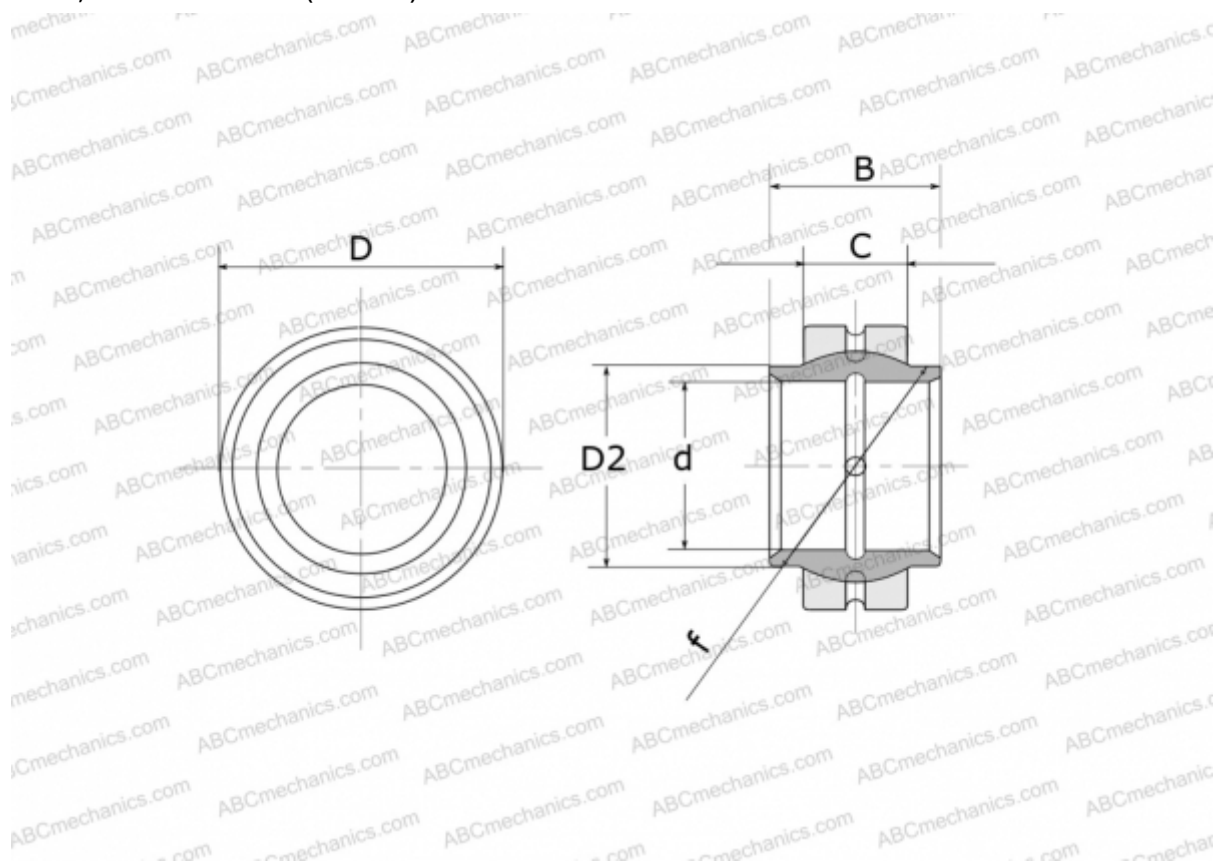

Technical specification

DIMENSIONS, MM

d	80,000
D	120,000
D2	91,000
B	80,000
f	105,000
C	45,000

WEIGHT, KG 2,550

MANUFACTURER [FLURO](#)