

## GE 100 LO FLURO

Spherical plain bearings

TYPE: Plain bearings, Spherical plain bearings and rod ends, Radial spherical plain bearings, Requiring maintenance, Series GE...LO (FLURO)

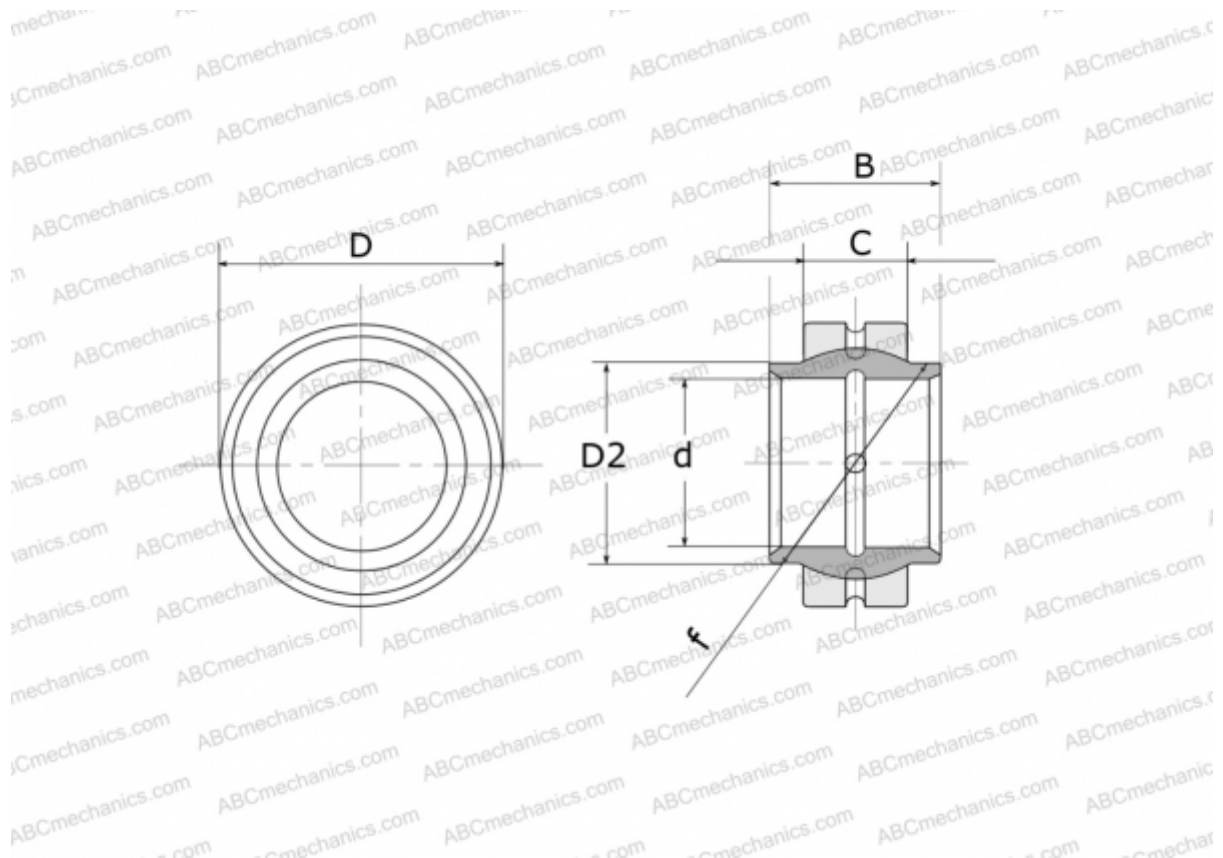

### Technical specification

#### DIMENSIONS, MM

d	100,000
D	150,000
D2	113,000
B	100,000
f	130,000
C	55,000

**WEIGHT, KG** 4,870

**MANUFACTURER** [FLURO](#)