

## GE 110 LO FLURO

Spherical plain bearings

TYPE: Plain bearings, Spherical plain bearings and rod ends, Radial spherical plain bearings, Requiring maintenance, Series GE...LO (FLURO)

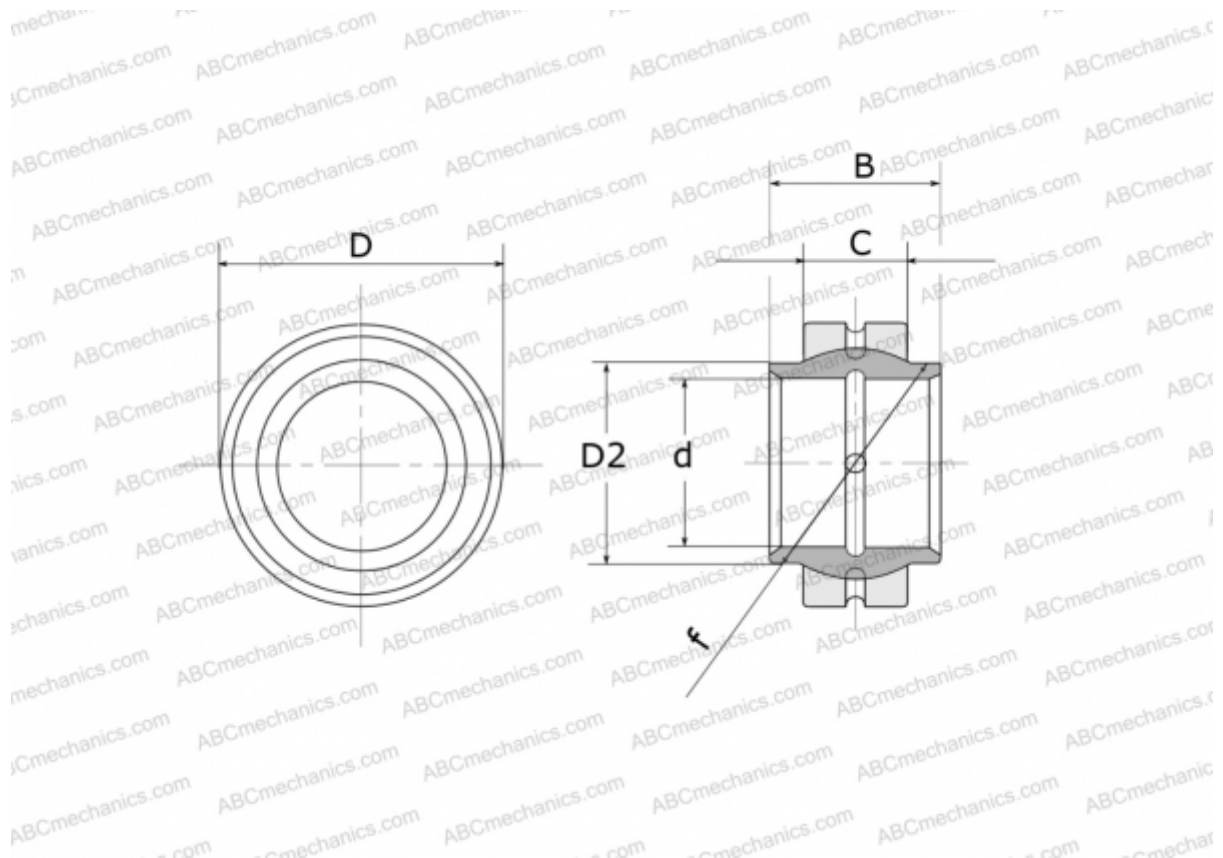

### Technical specification

#### DIMENSIONS, MM

d	110,000
D	160,000
D2	124,000
B	110,000
f	140,000
C	55,000

**WEIGHT, KG** 5,530

**MANUFACTURER** [FLURO](#)