

GE 6 FO FLURO

Spherical plain bearings

TYPE: Plain bearings, Spherical plain bearings and rod ends, Radial spherical plain bearings, Requiring maintenance, Series GE...FO (FLURO)

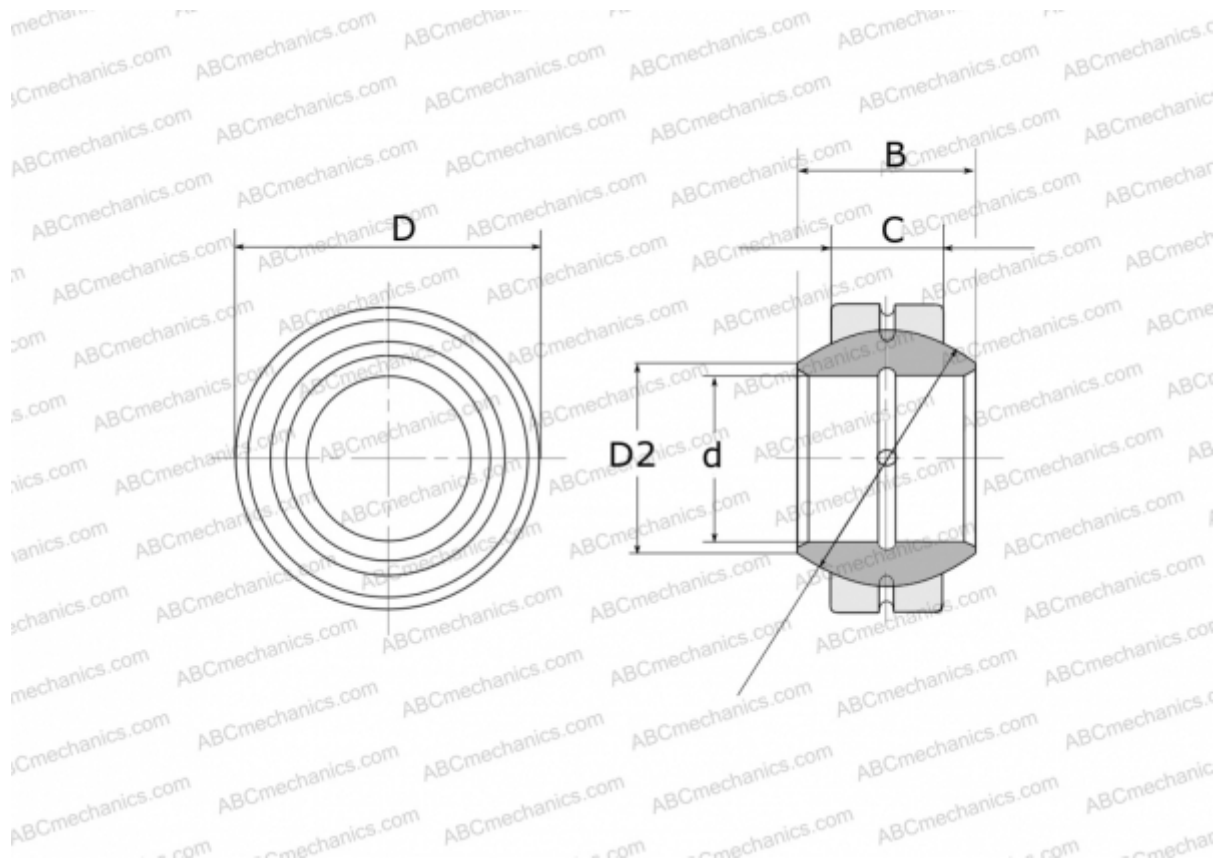

Technical specification

DIMENSIONS, MM

d	6,000
D	16,000
D2	9,300
B	9,000
f	13,000
C	5,000

WEIGHT, KG 0,008

MANUFACTURER [FLURO](#)