

GE 10 FO FLURO

Spherical plain bearings

TYPE: Plain bearings, Spherical plain bearings and rod ends, Radial spherical plain bearings, Requiring maintenance, Series GE...FO (FLURO)

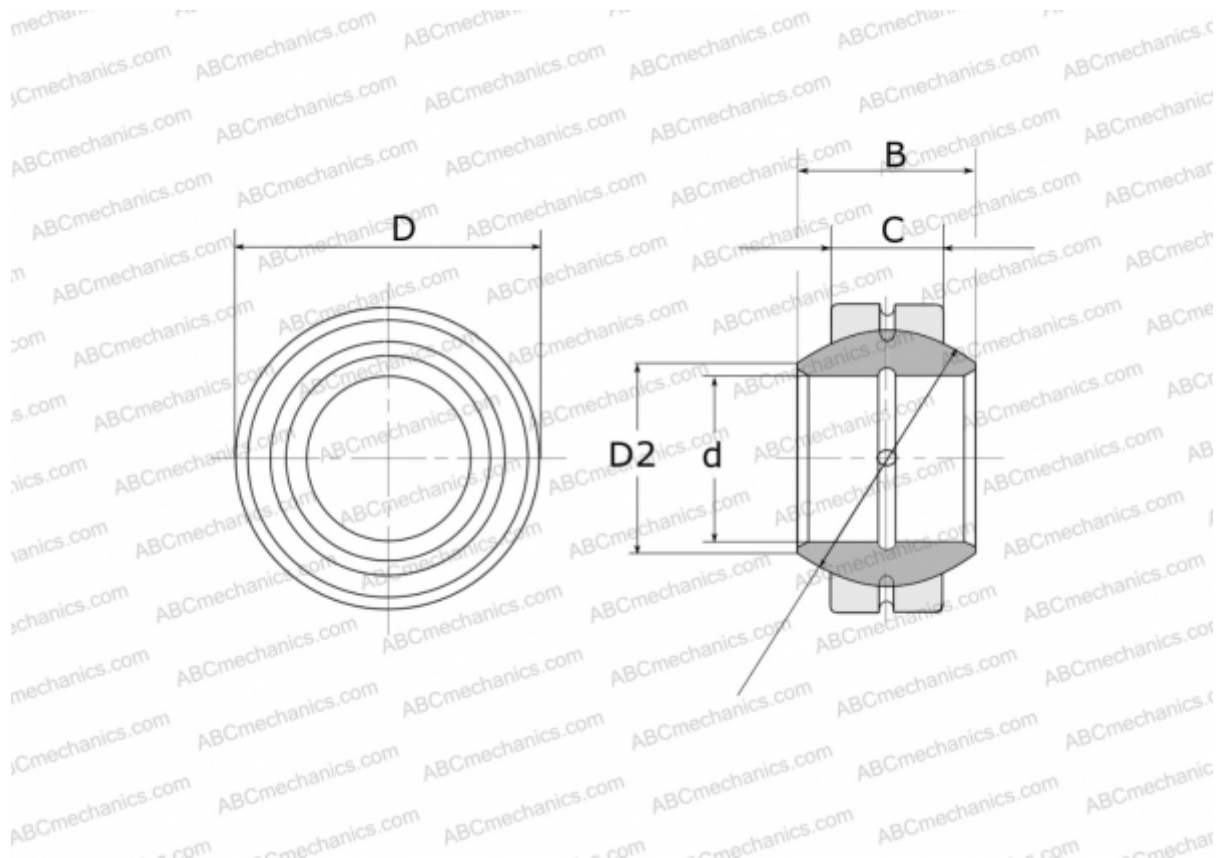

Technical specification

DIMENSIONS, MM

d	10,000
D	22,000
D2	13,400
B	12,000
f	18,000
C	7,000

WEIGHT, KG 0,021

MANUFACTURER [FLURO](#)