

GE 40 FO FLURO

Spherical plain bearings

TYPE: Plain bearings, Spherical plain bearings and rod ends, Radial spherical plain bearings, Requiring maintenance, Series GE...FO (FLURO)

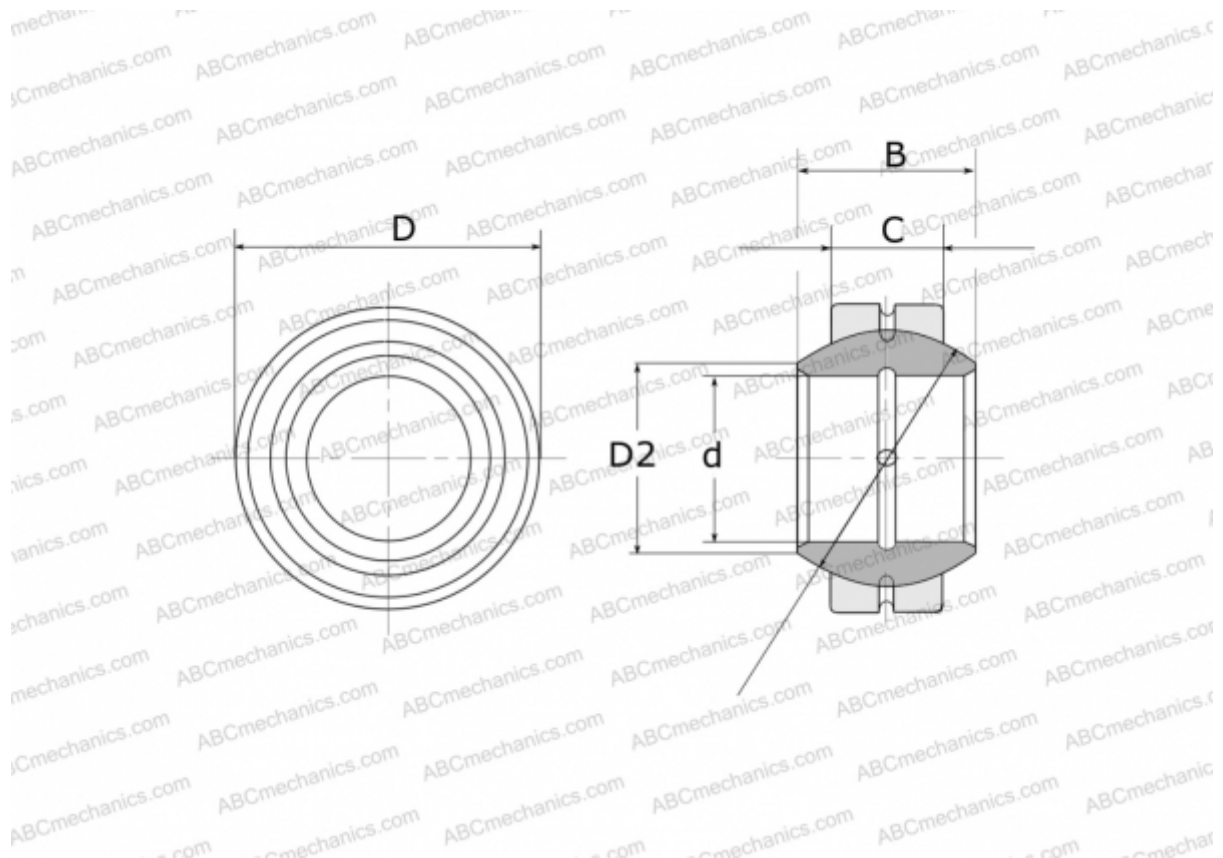

Technical specification

DIMENSIONS, MM

d	40,000
D	68,000
D2	44,700
B	40,000
f	60,000
C	25,000

WEIGHT, KG 0,535

MANUFACTURER [FLURO](#)