

GE 50 FO FLURO

Spherical plain bearings

TYPE: Plain bearings, Spherical plain bearings and rod ends, Radial spherical plain bearings, Requiring maintenance, Series GE...FO (FLURO)

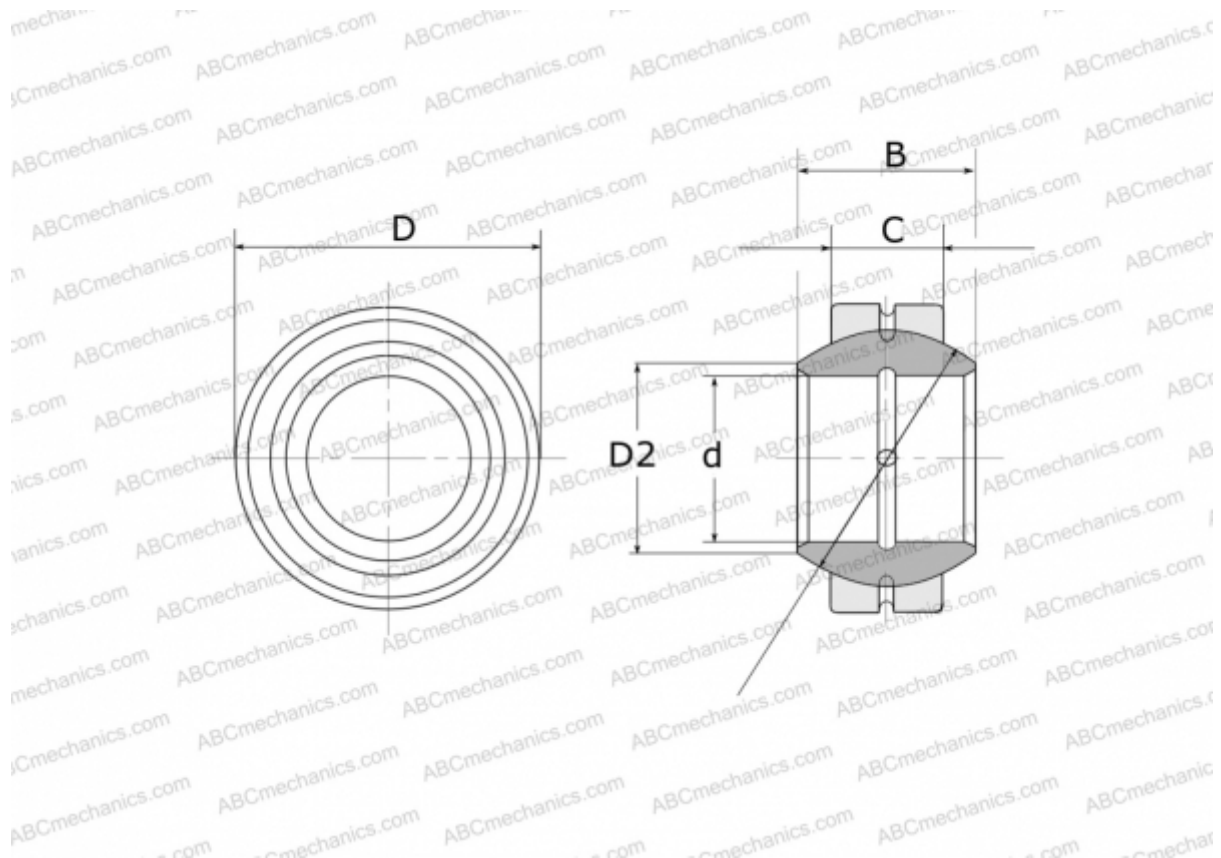

Technical specification

DIMENSIONS, MM

d	50,000
D	90,000
D2	57,100
B	56,000
f	80,000
C	36,000

WEIGHT, KG 1,420

MANUFACTURER [FLURO](#)