

GE 80 FO FLURO

Spherical plain bearings

TYPE: Plain bearings, Spherical plain bearings and rod ends, Radial spherical plain bearings, Requiring maintenance, Series GE...FO (FLURO)

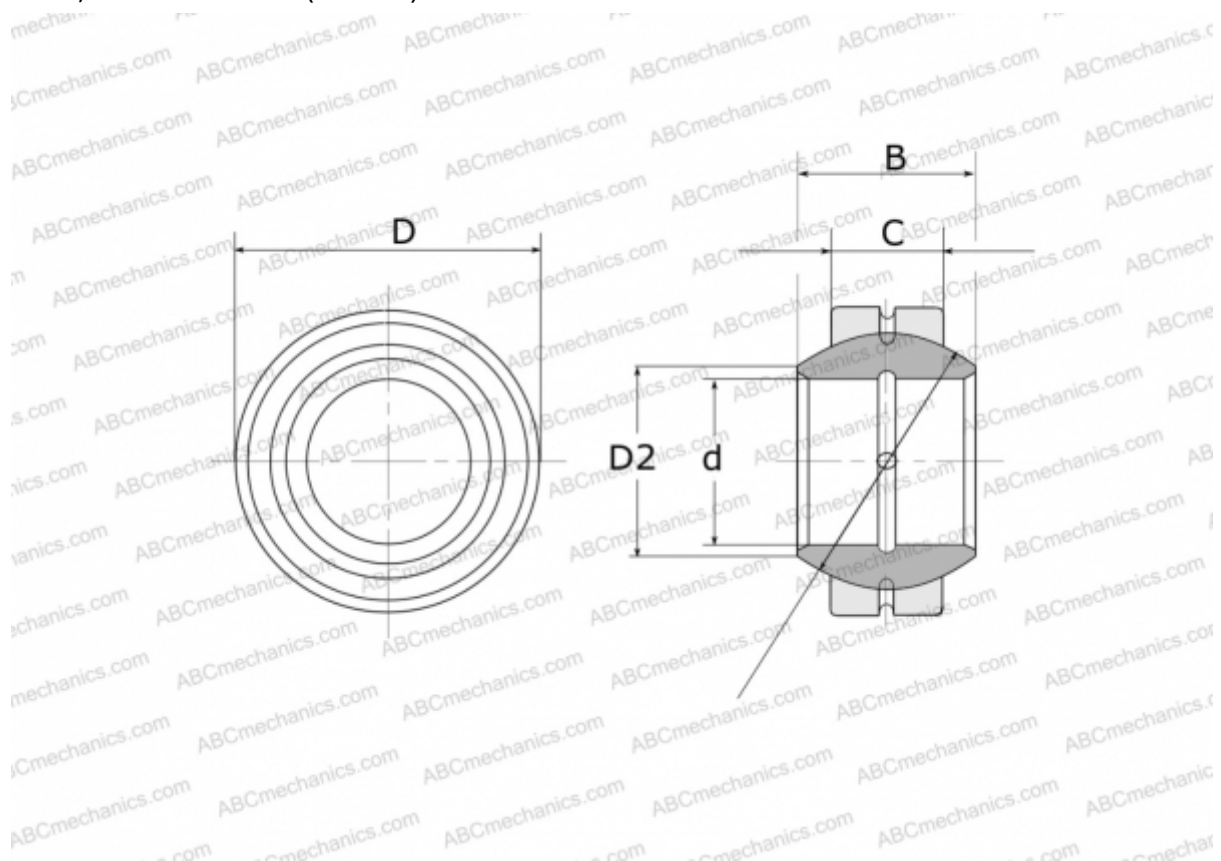

Technical specification

DIMENSIONS, MM

d	80,000
D	130,000
D2	87,100
B	75,000
f	115,000
C	50,000

WEIGHT, KG 3,610

MANUFACTURER [FLURO](#)