

GE 100 FO FLURO

Spherical plain bearings

TYPE: Plain bearings, Spherical plain bearings and rod ends, Radial spherical plain bearings, Requiring maintenance, Series GE...FO (FLURO)

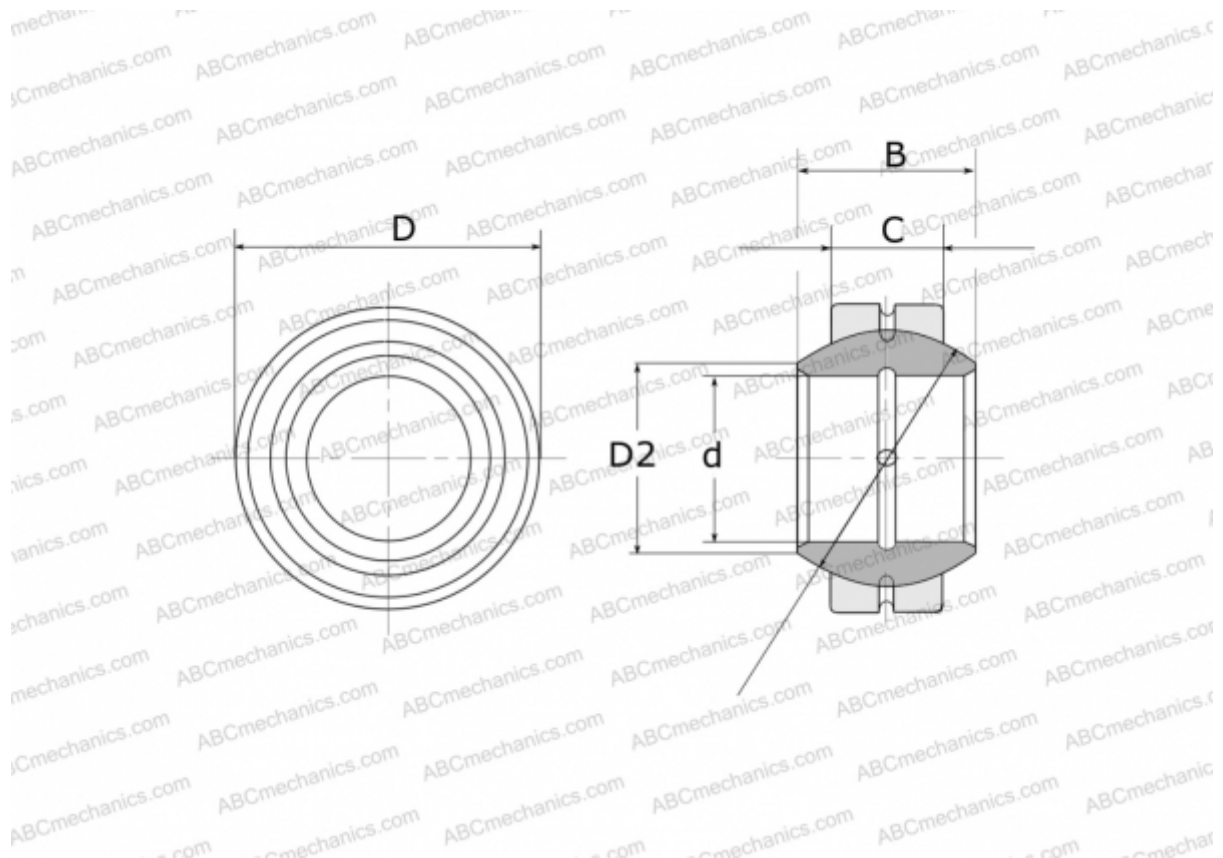

Technical specification

DIMENSIONS, MM

d	100,000
D	160,000
D2	111,200
B	85,000
f	140,000
C	55,000

WEIGHT, KG 6,040

MANUFACTURER [FLURO](#)