

GE 110 FO FLURO

Spherical plain bearings

TYPE: Plain bearings, Spherical plain bearings and rod ends, Radial spherical plain bearings, Requiring maintenance, Series GE...FO (FLURO)

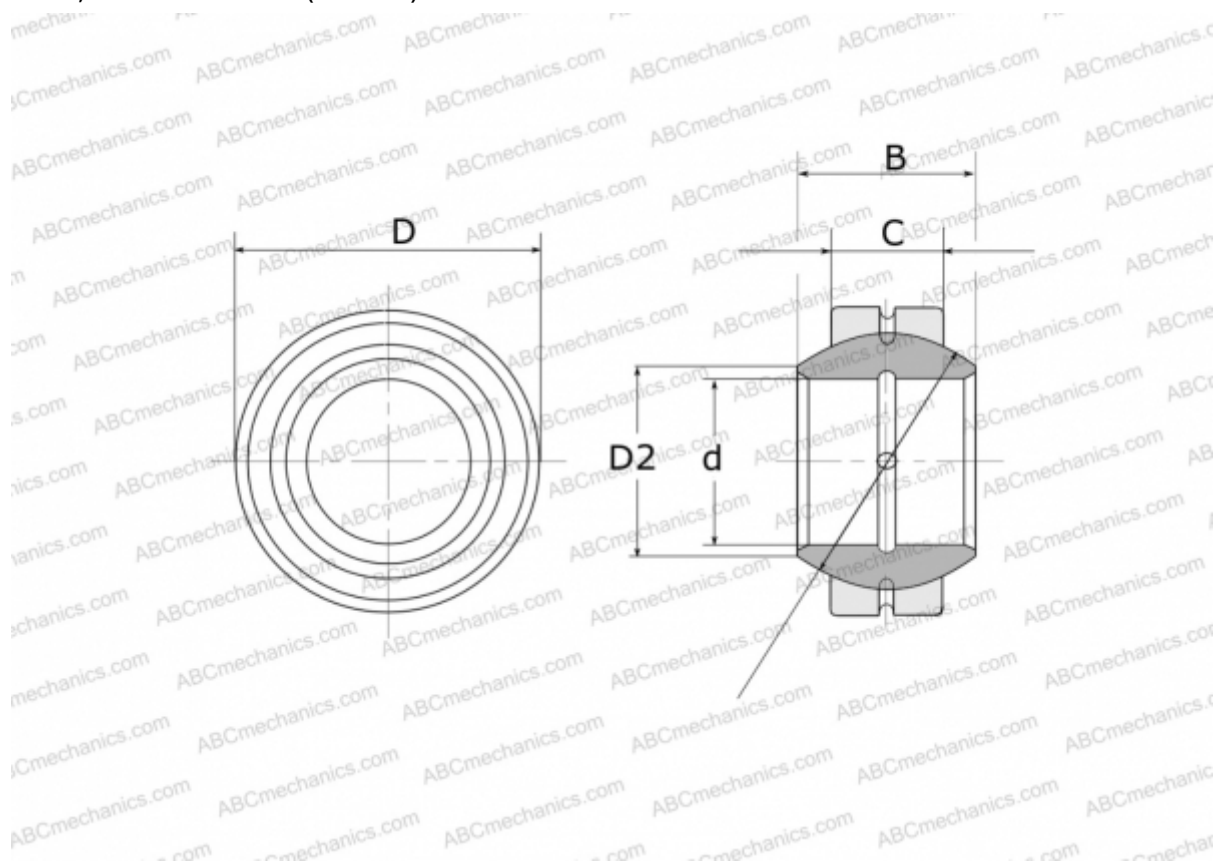

Technical specification

DIMENSIONS, MM

d	110,000
D	180,000
D2	124,800
B	100,000
f	160,000
C	70,000

WEIGHT, KG 9,740

MANUFACTURER [FLURO](#)