

GE 120 FO FLURO

Spherical plain bearings

TYPE: Plain bearings, Spherical plain bearings and rod ends, Radial spherical plain bearings, Requiring maintenance, Series GE...FO (FLURO)

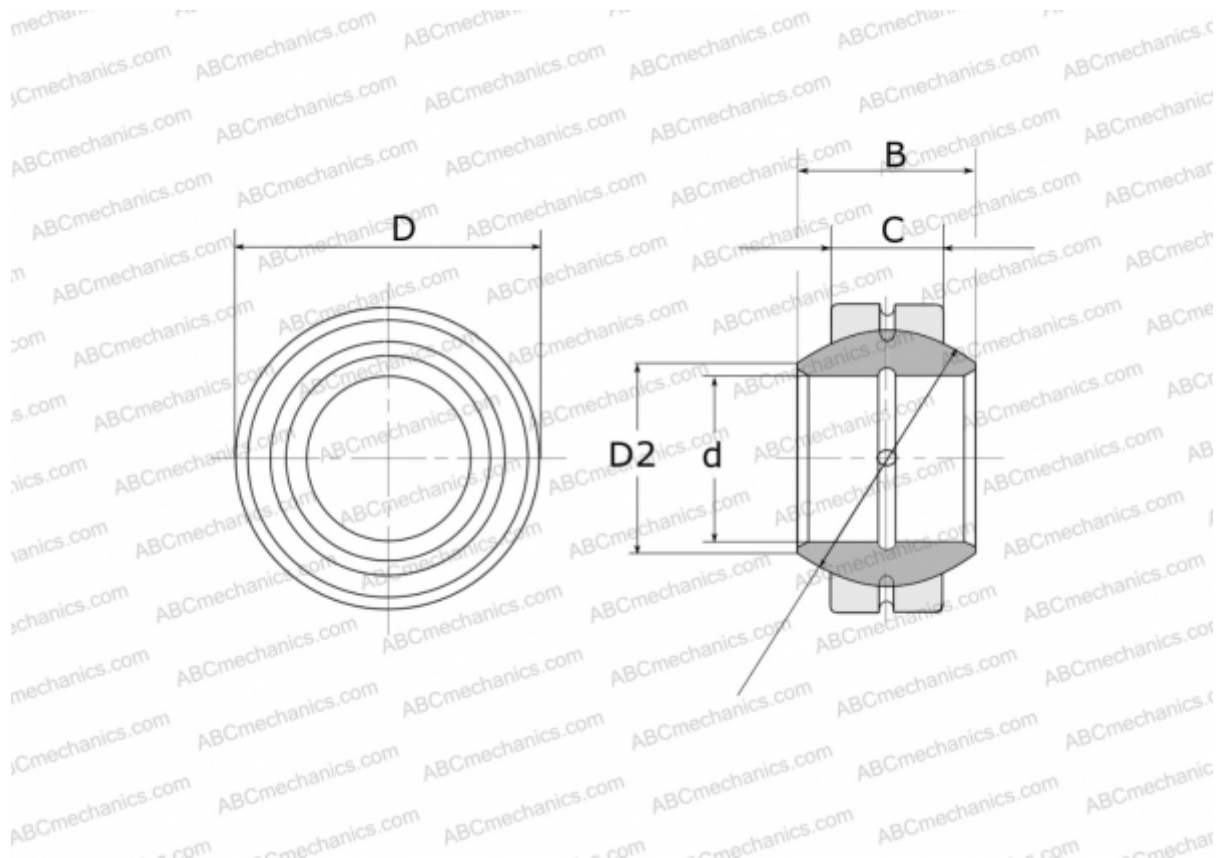

Technical specification

DIMENSIONS, MM

d	120,000
D	210,000
D2	138,400
B	115,000
f	180,000
C	70,000

WEIGHT, KG 15,100

MANUFACTURER [FLURO](#)