

GE 200 FO FLURO

Spherical plain bearings

TYPE: Plain bearings, Spherical plain bearings and rod ends, Radial spherical plain bearings, Requiring maintenance, Series GE...FO (FLURO)

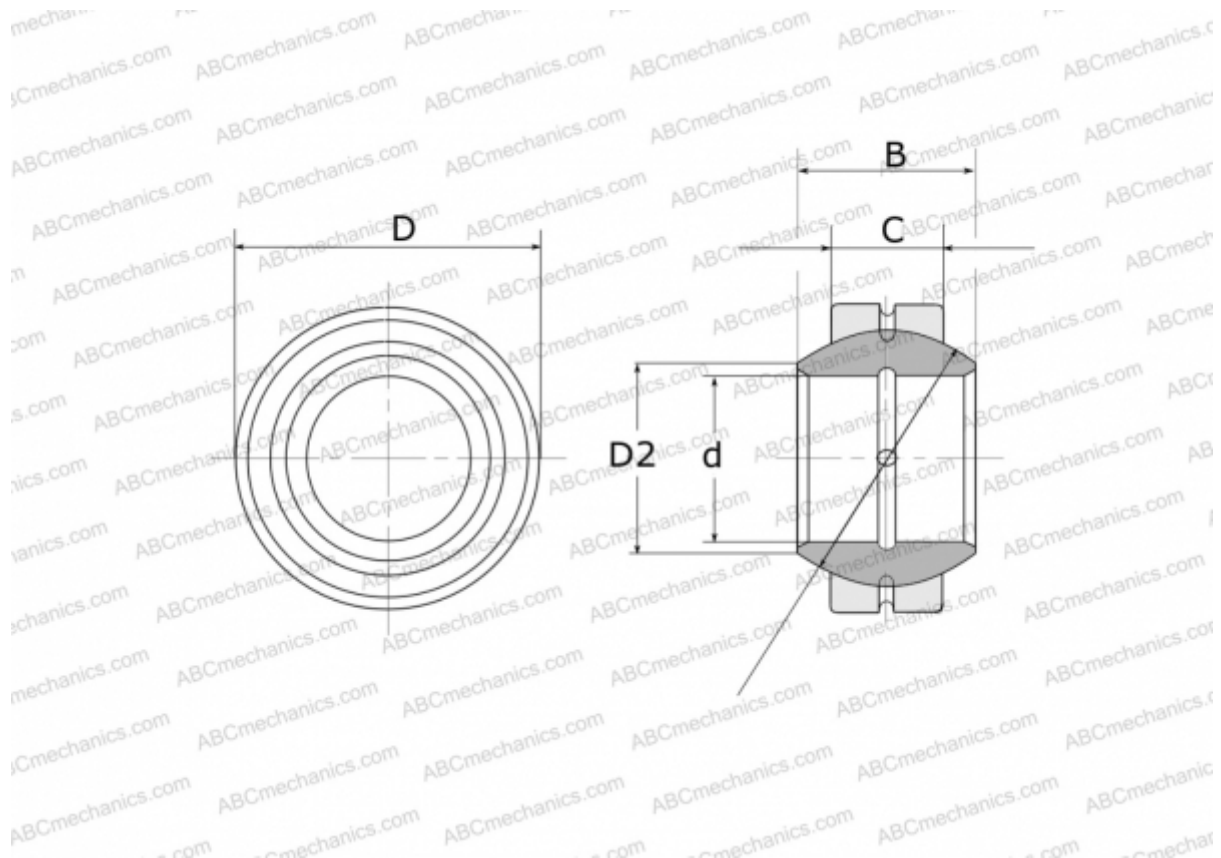

Technical specification

DIMENSIONS, MM

d	200,000
D	320,000
D2	220,000
B	165,000
f	275,000
C	100,000

WEIGHT, KG 44,900

MANUFACTURER [FLURO](#)