

GE 240 FO FLURO

Spherical plain bearings

TYPE: Plain bearings, Spherical plain bearings and rod ends, Radial spherical plain bearings, Requiring maintenance, Series GE...FO (FLURO)

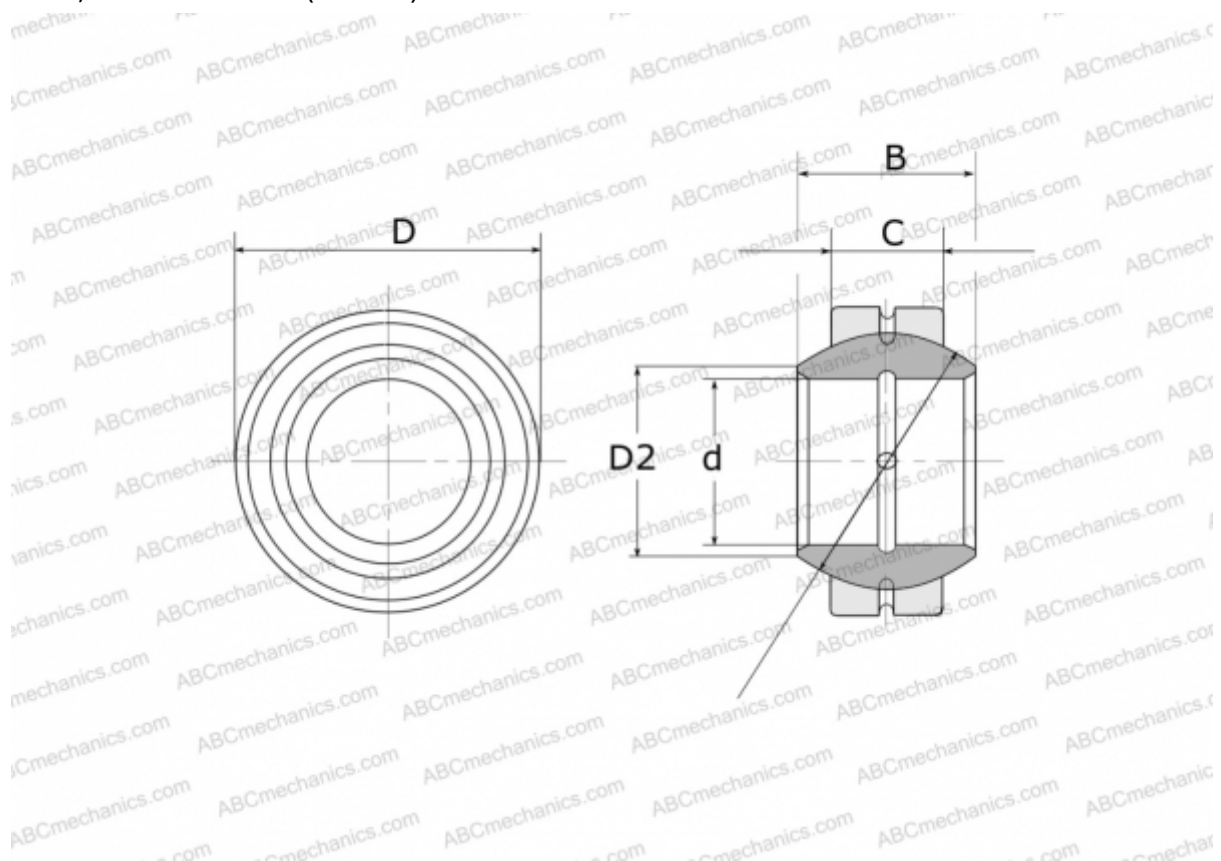

Technical specification

DIMENSIONS, MM

d	240,000
D	370,000
D2	263,600
B	190,000
f	325,000
C	110,000

WEIGHT, KG 65,300

MANUFACTURER [FLURO](#)