

GE 260 FO FLURO

Spherical plain bearings

TYPE: Plain bearings, Spherical plain bearings and rod ends, Radial spherical plain bearings, Requiring maintenance, Series GE...FO (FLURO)

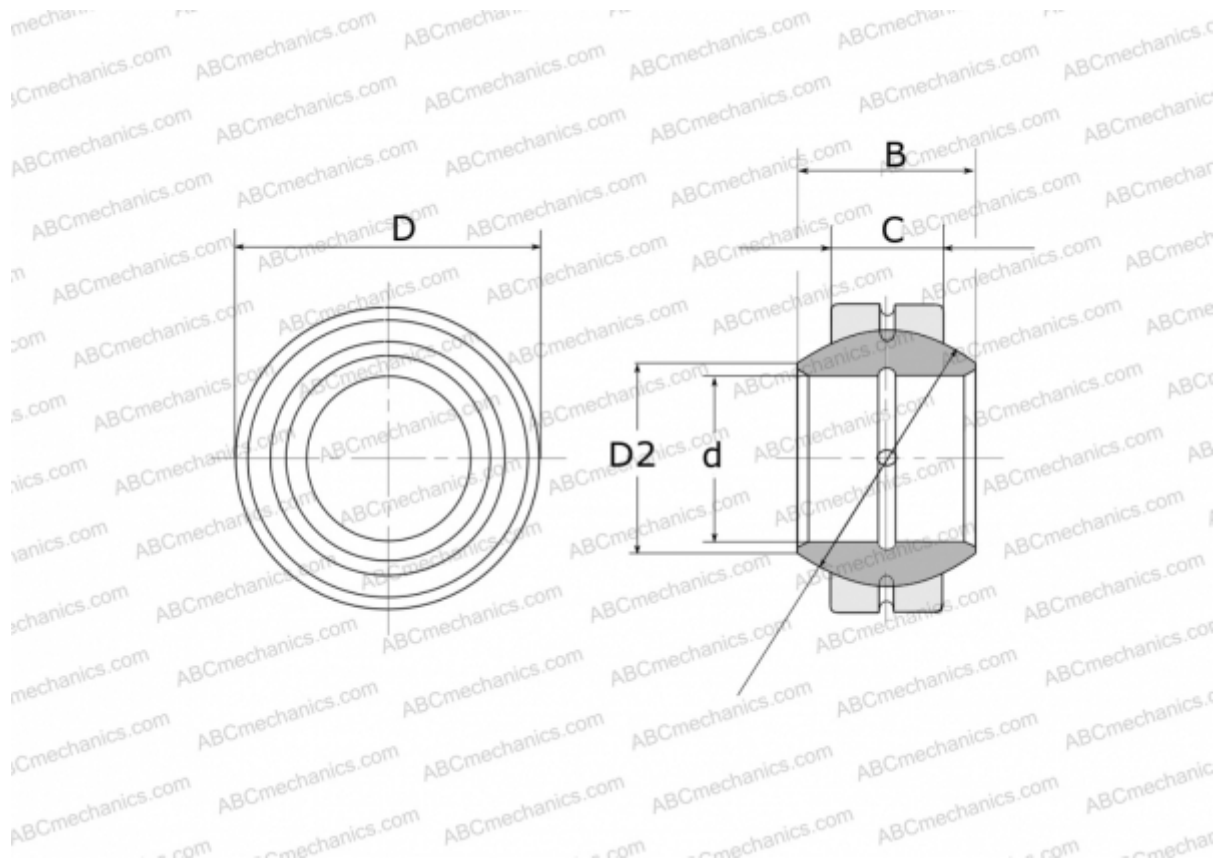

Technical specification

DIMENSIONS, MM

d	260,000
D	400,000
D2	283,600
B	205,000
f	350,000
C	120,000

WEIGHT, KG 82,000

MANUFACTURER [FLURO](#)