

GE 70 FO-2RS FLURO

Spherical plain bearings

TYPE: Plain bearings, Spherical plain bearings and rod ends, Radial spherical plain bearings, Requiring maintenance, Series GE...FO-2RS (FLURO), contact seals on both side

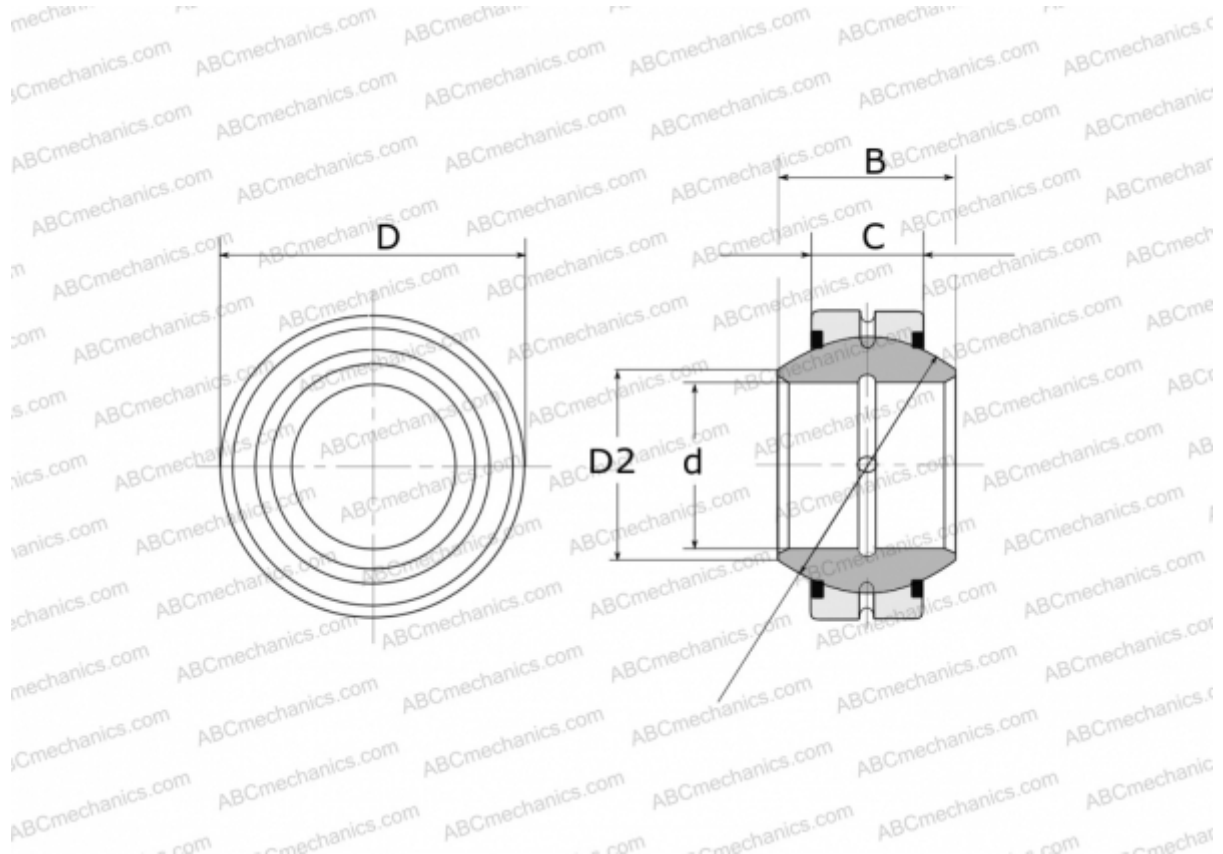

Technical specification

DIMENSIONS, MM

d	70,000
D	120,000
D2	78,200
B	70,000
f	105,000
C	45,000

WEIGHT, KG 3,010

MANUFACTURER [FLURO](#)