

GE 40 AW FLURO

Spherical plain bearings

TYPE: Plain bearings, Spherical plain bearings and rod ends, Thrust spherical plain bearings, Maintenance free, Series GE..-AW (FLURO)

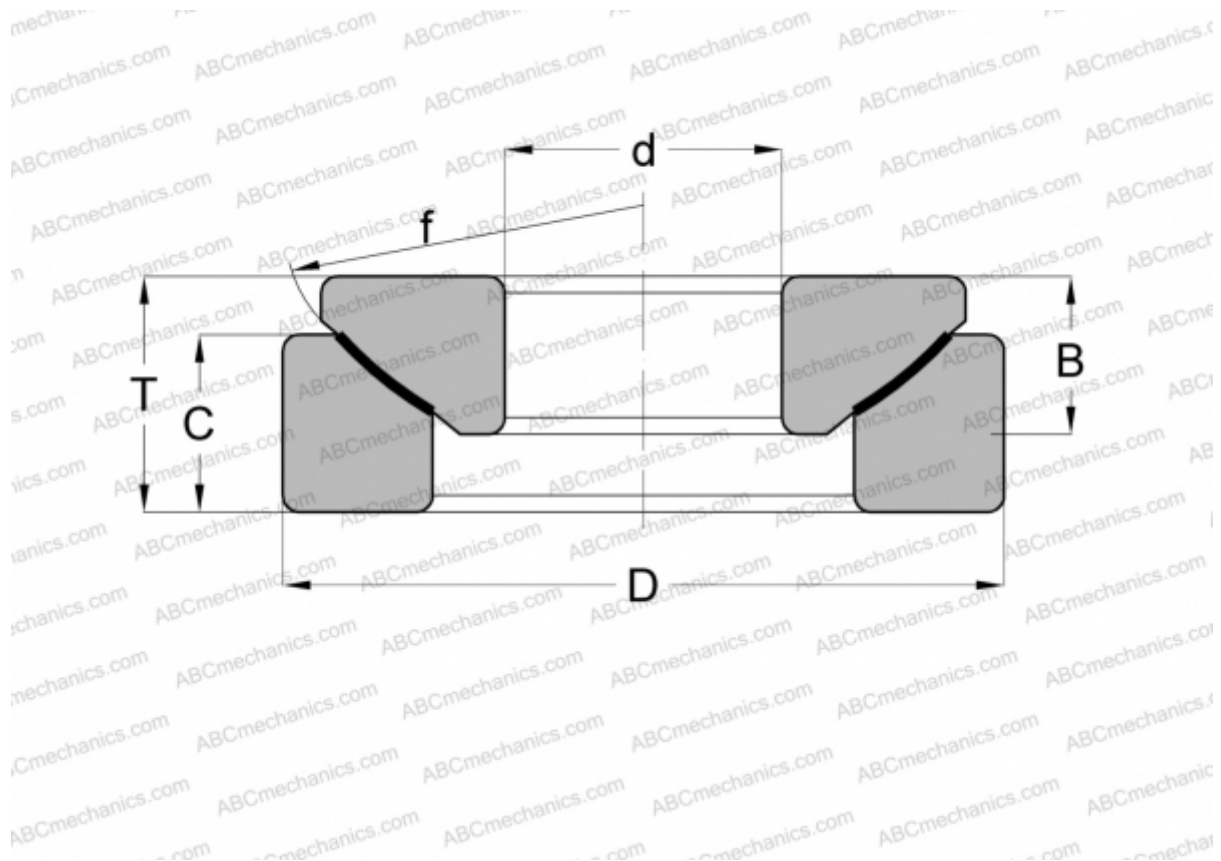

Technical specification

DIMENSIONS, MM

d	40,000
D	105,000
B	27,000
f	114,000
T	32,000
C	21,500

MANUFACTURER [FLURO](#)