

GE 50 AW FLURO

Spherical plain bearings

TYPE: Plain bearings, Spherical plain bearings and rod ends, Thrust spherical plain bearings, Maintenance free, Series GE..-AW (FLURO)

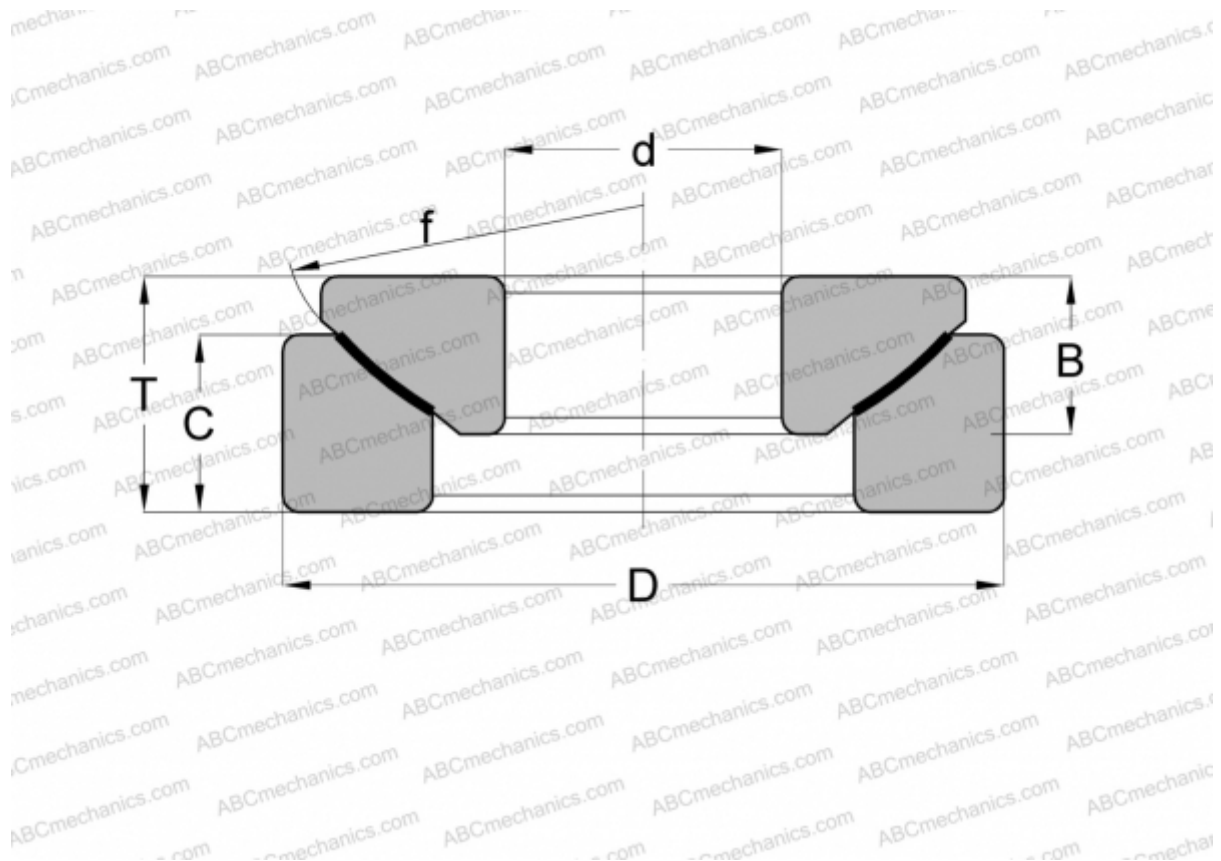

Technical specification

DIMENSIONS, MM

d	50,000
D	130,000
B	33,000
f	139,000
T	42,500
C	30,500

MANUFACTURER [FLURO](#)