

GE 100 AW FLURO

Spherical plain bearings

TYPE: Plain bearings, Spherical plain bearings and rod ends, Thrust spherical plain bearings, Maintenance free, Series GE..-AW (FLURO)

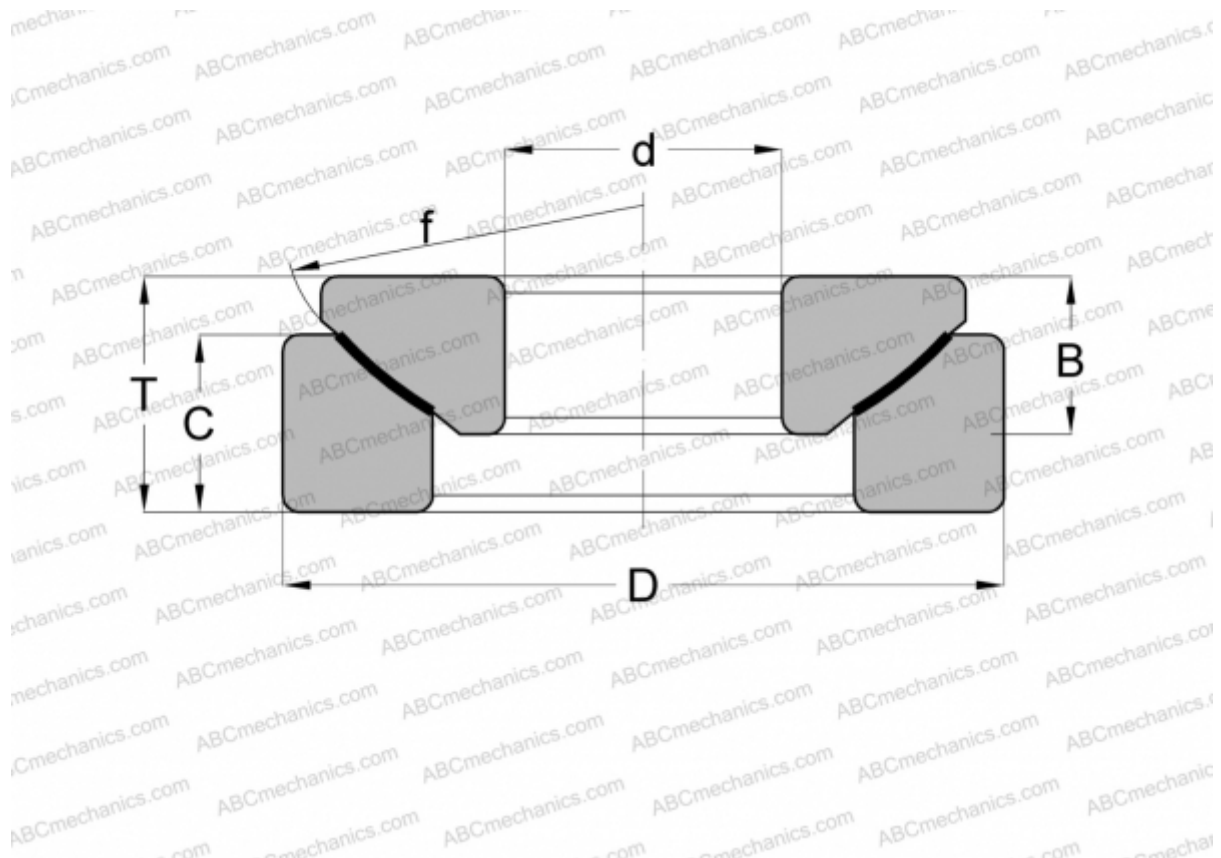

Technical specification

DIMENSIONS, MM

d	100,000
D	210,000
B	51,000
f	222,000
T	59,000
C	46,000

MANUFACTURER [FLURO](#)