

GE 140 AW FLURO

Spherical plain bearings

TYPE: Plain bearings, Spherical plain bearings and rod ends, Thrust spherical plain bearings, Maintenance free, Series GE..-AW (FLURO)

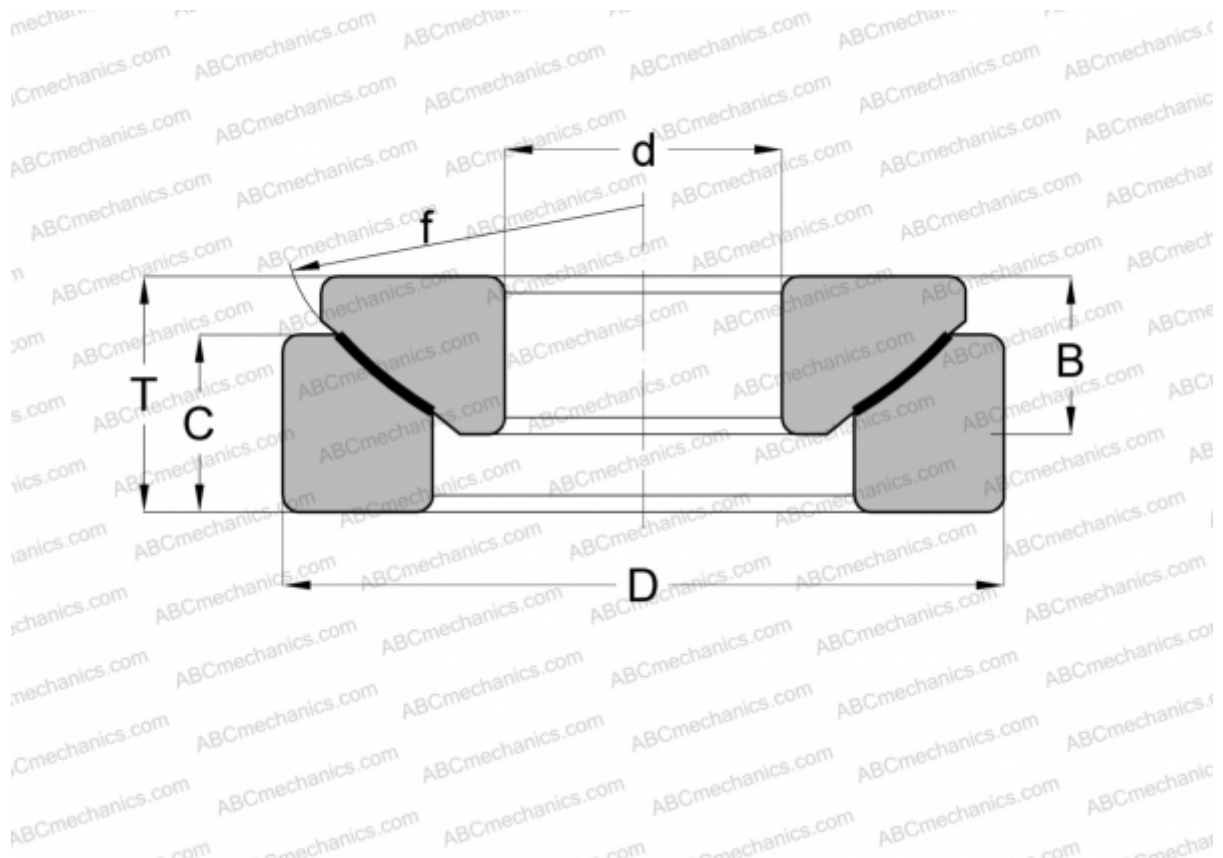

Technical specification

DIMENSIONS, MM

d	140,000
D	260,000
B	61,000
f	274,000
T	72,000
C	54,000

MANUFACTURER [FLURO](#)