

GE 260 AW FLURO

Spherical plain bearings

TYPE: Plain bearings, Spherical plain bearings and rod ends, Thrust spherical plain bearings, Maintenance free, Series GE..-AW (FLURO)

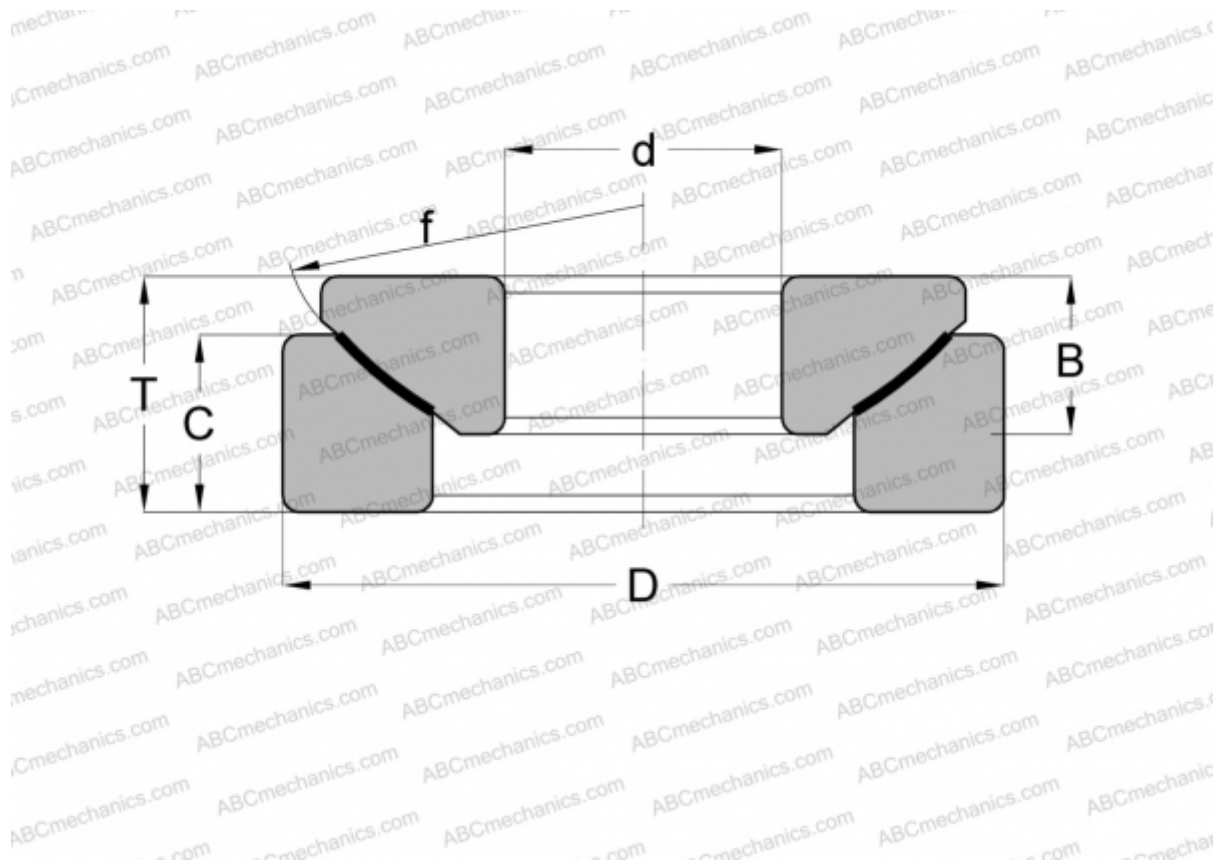

Technical specification

DIMENSIONS, MM

d	260,000
D	430,000
B	95,000
f	449,000
T	115,000
C	80,000

MANUFACTURER [FLURO](#)