

GE 10 AX FLURO

Spherical plain bearings

TYPE: Plain bearings, Spherical plain bearings and rod ends, Thrust spherical plain bearings,
Requiring maintenance, Series GE..-AX (FLURO)

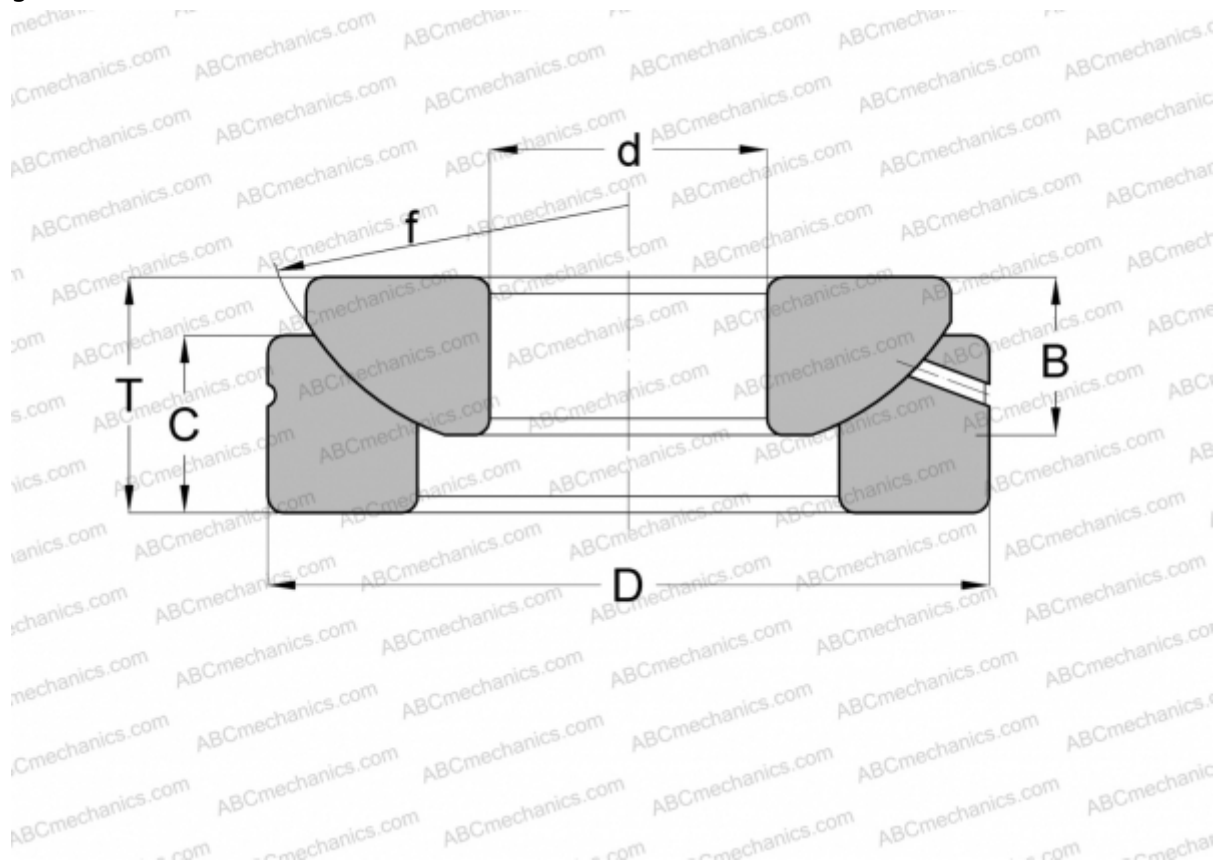

Technical specification

DIMENSIONS, MM

d	10,000
D	30,000
B	7,500
f	32,000
T	9,500
C	7,000

WEIGHT, KG 0,036

MANUFACTURER [FLURO](#)