

GE 12 AX FLURO

Spherical plain bearings

TYPE: Plain bearings, Spherical plain bearings and rod ends, Thrust spherical plain bearings,
Requiring maintenance, Series GE..-AX (FLURO)

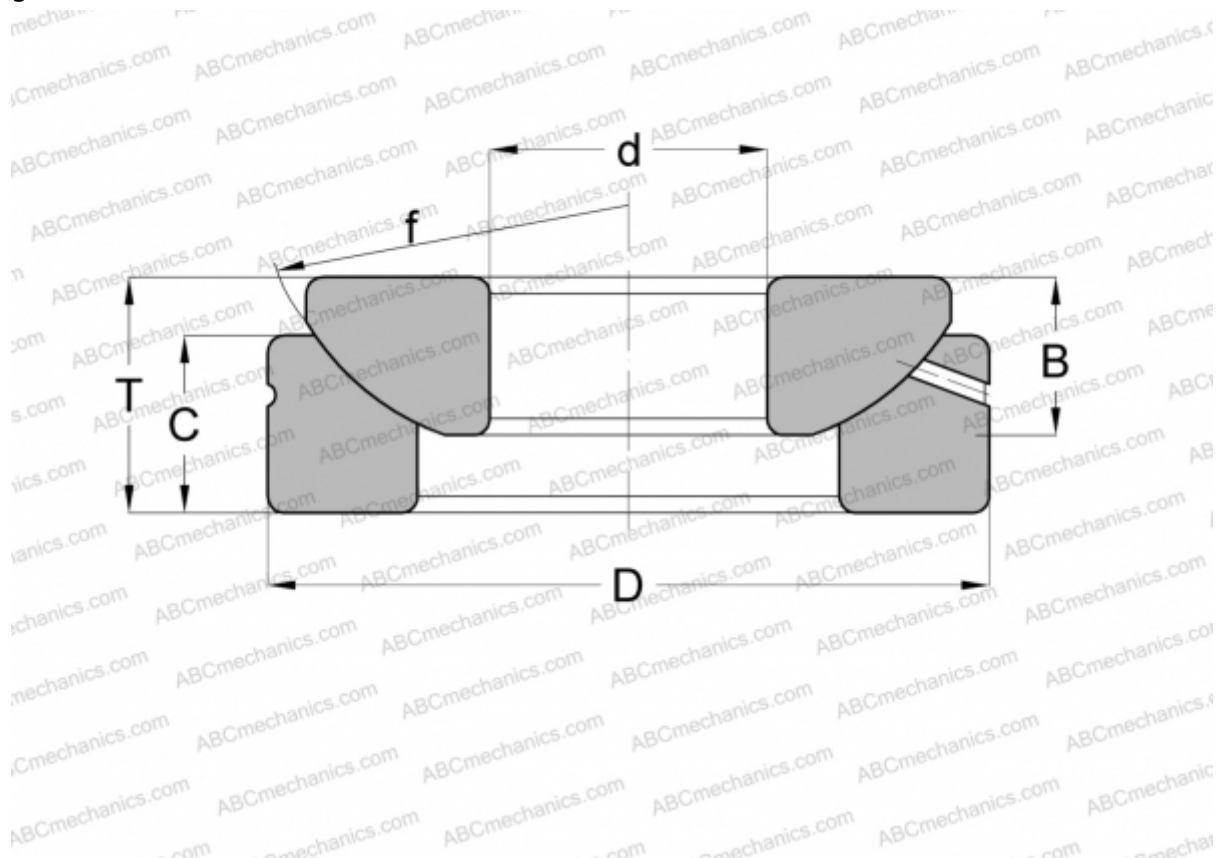

Technical specification

DIMENSIONS, MM

d	12,000
D	35,000
B	9,500
f	38,000
T	13,000
C	9,300

WEIGHT, KG 0,072

MANUFACTURER [FLURO](#)