

GE 17 AX FLURO

Spherical plain bearings

TYPE: Plain bearings, Spherical plain bearings and rod ends, Thrust spherical plain bearings,
Requiring maintenance, Series GE..-AX (FLURO)

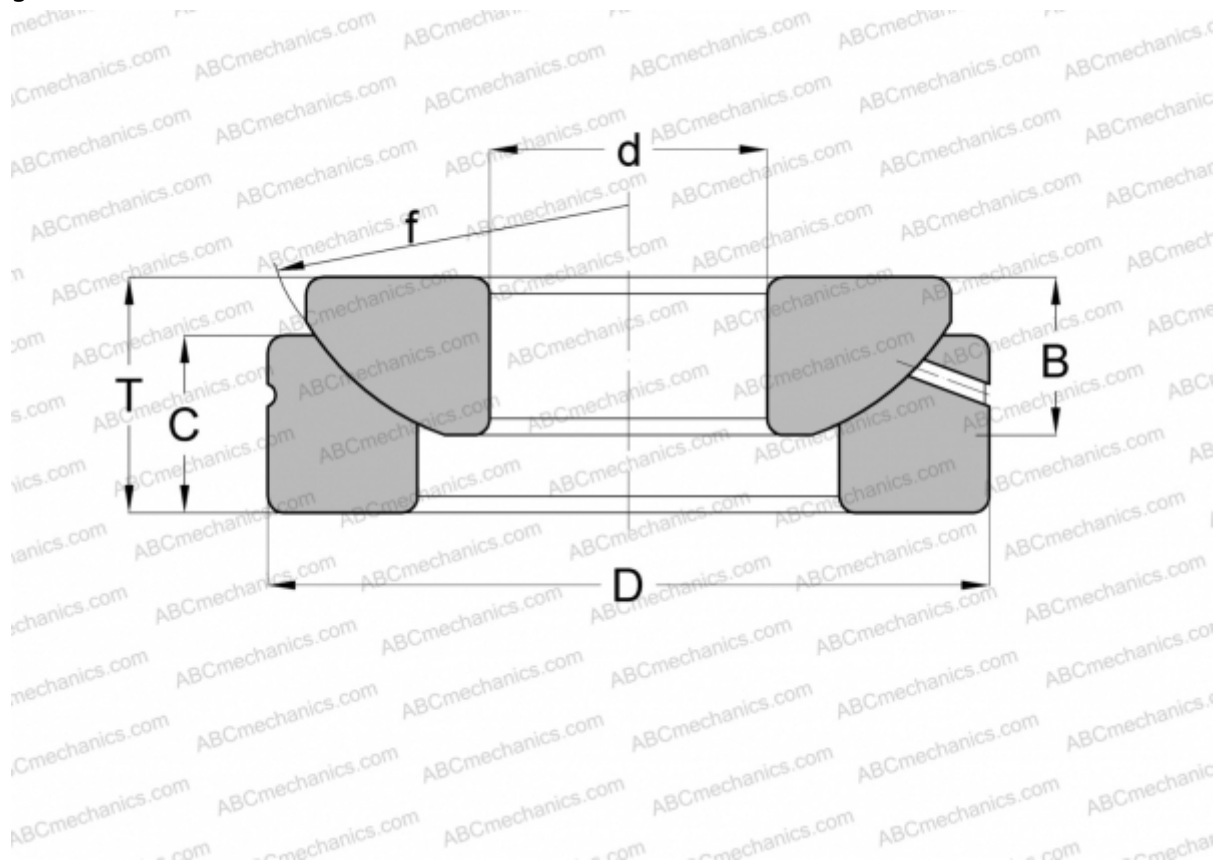

Technical specification

DIMENSIONS, MM

d	17,000
D	47,000
B	11,800
f	52,000
T	16,000
C	11,200

WEIGHT, KG 0,137

MANUFACTURER [FLURO](#)