

GE 20 AX FLURO

Spherical plain bearings

TYPE: Plain bearings, Spherical plain bearings and rod ends, Thrust spherical plain bearings,
Requiring maintenance, Series GE..-AX (FLURO)

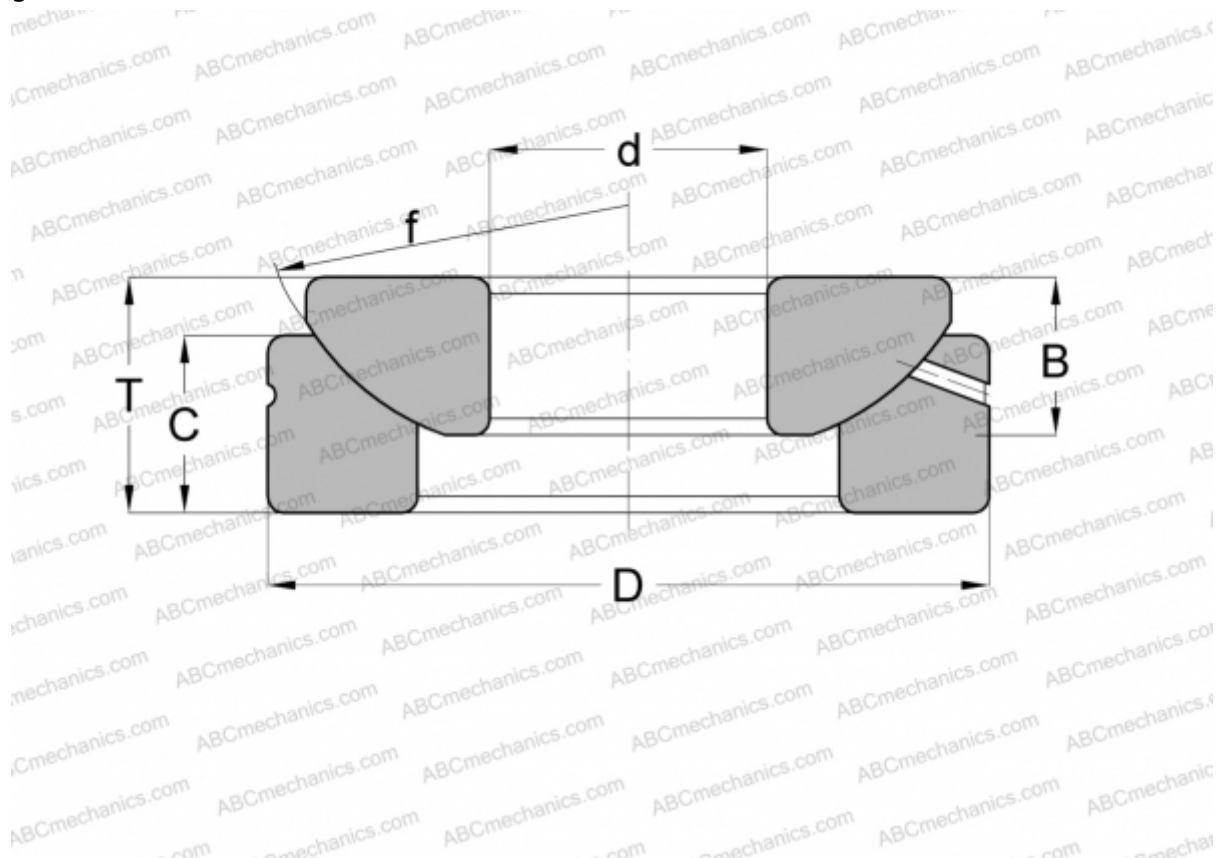

Technical specification

DIMENSIONS, MM

d	20,000
D	55,000
B	14,500
f	60,000
T	20,000
C	13,800

WEIGHT, KG 0,246

MANUFACTURER [FLURO](#)