

GE 40 AX FLURO

Spherical plain bearings

TYPE: Plain bearings, Spherical plain bearings and rod ends, Thrust spherical plain bearings,
Requiring maintenance, Series GE..-AX (FLURO)

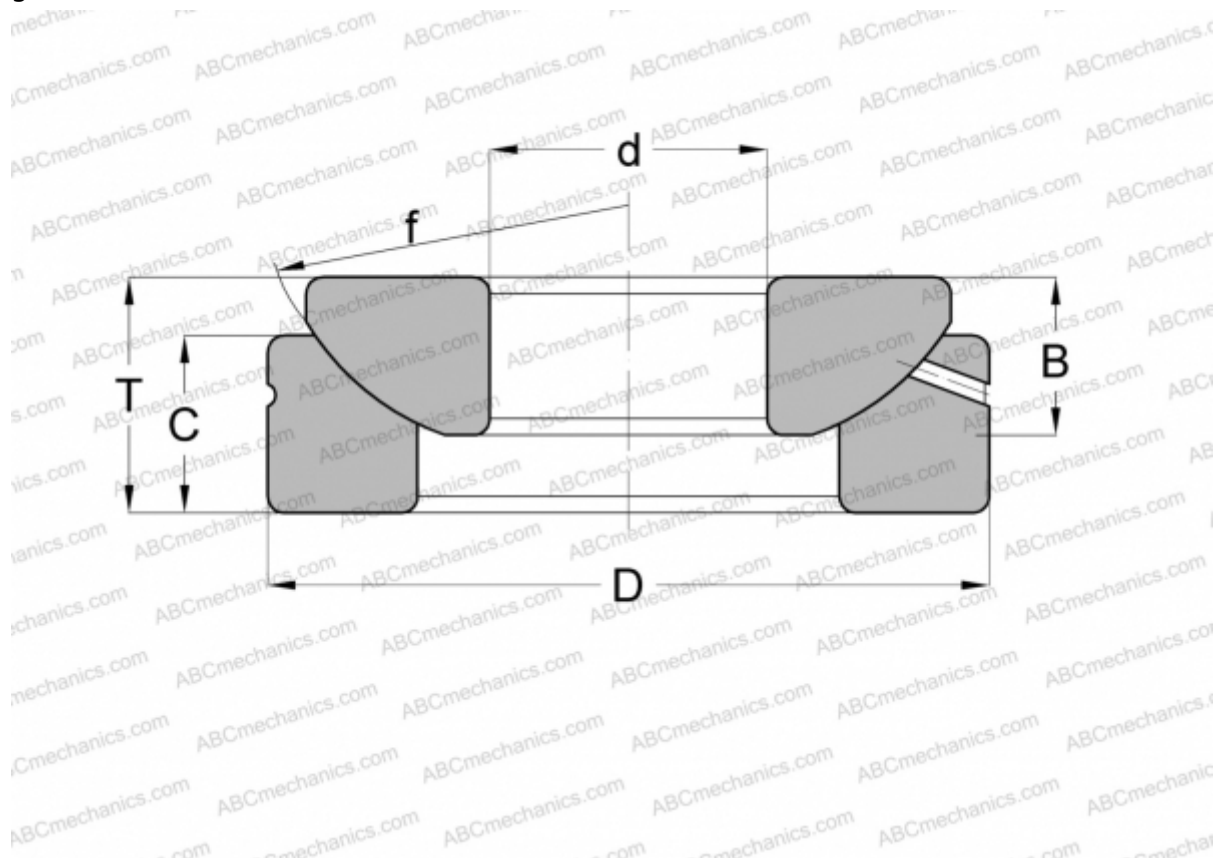

Technical specification

DIMENSIONS, MM

d	40,000
D	105,000
B	27,000
f	114,000
T	32,000
C	21,500

WEIGHT, KG 1,590

MANUFACTURER [FLURO](#)