

GE 50 AX FLURO

Spherical plain bearings

TYPE: Plain bearings, Spherical plain bearings and rod ends, Thrust spherical plain bearings,
Requiring maintenance, Series GE..-AX (FLURO)

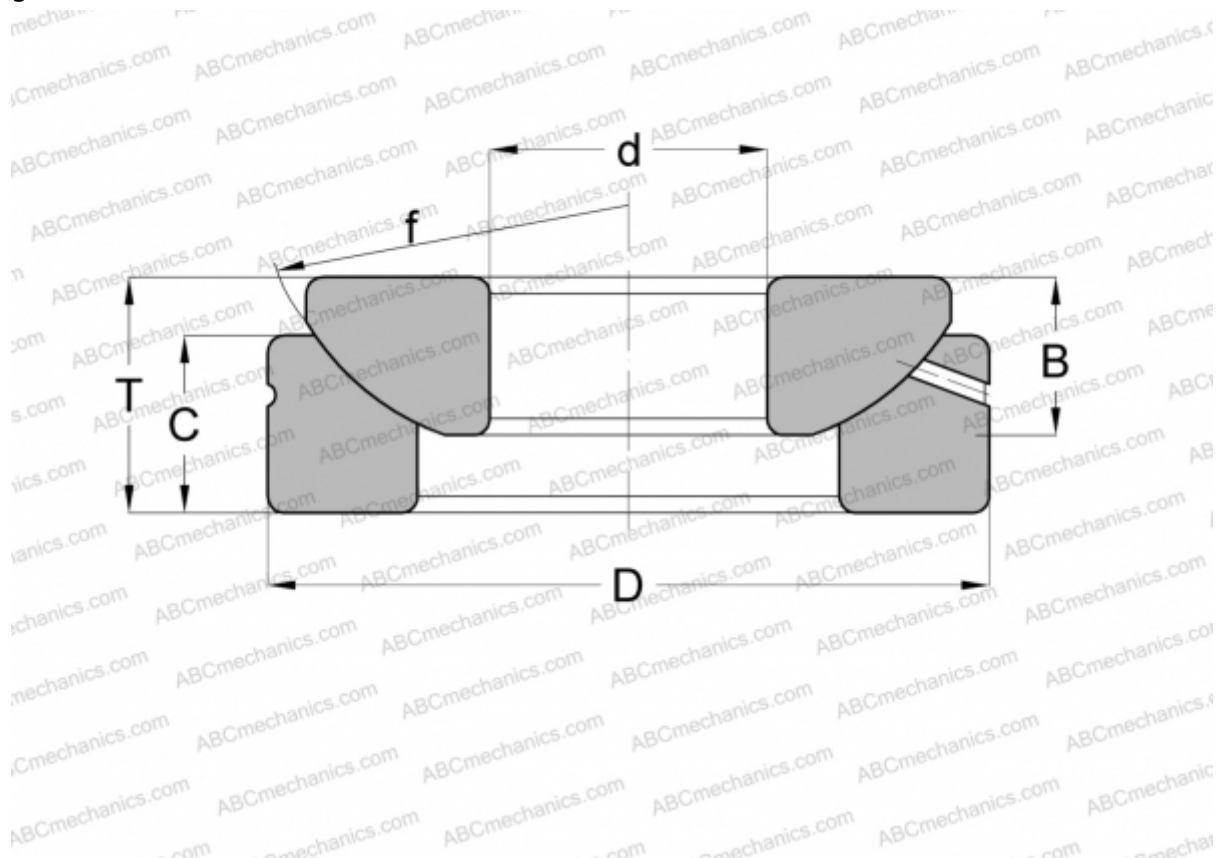

Technical specification

DIMENSIONS, MM

d	50,000
D	130,000
B	33,000
f	139,000
T	42,500
C	30,500

WEIGHT, KG 3,140

MANUFACTURER [FLURO](#)