

GE 60 AX FLURO

Spherical plain bearings

TYPE: Plain bearings, Spherical plain bearings and rod ends, Thrust spherical plain bearings,
Requiring maintenance, Series GE..-AX (FLURO)

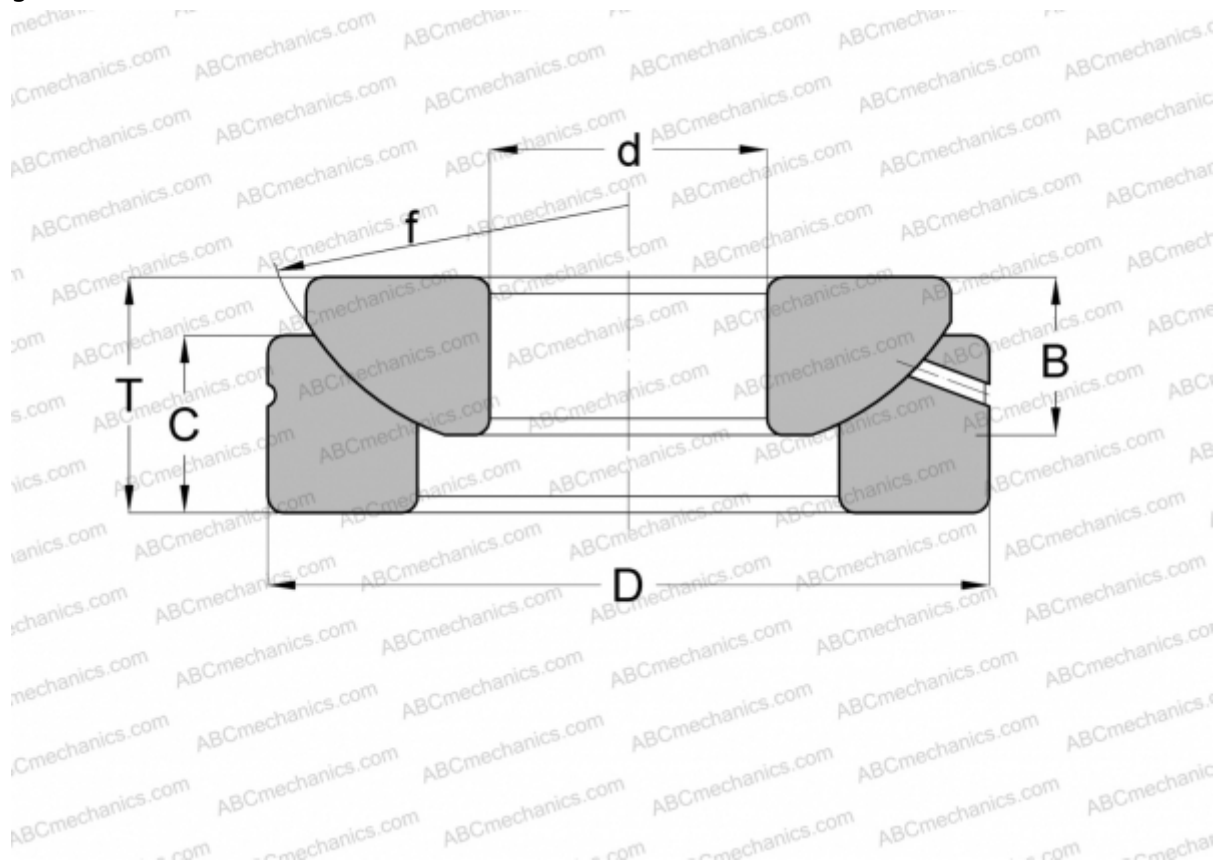

Technical specification

DIMENSIONS, MM

d	60,000
D	150,000
B	37,000
f	160,000
T	45,000
C	34,000

WEIGHT, KG 4,630

MANUFACTURER [FLURO](#)