

GE 70 AX FLURO

Spherical plain bearings

TYPE: Plain bearings, Spherical plain bearings and rod ends, Thrust spherical plain bearings,
Requiring maintenance, Series GE..-AX (FLURO)

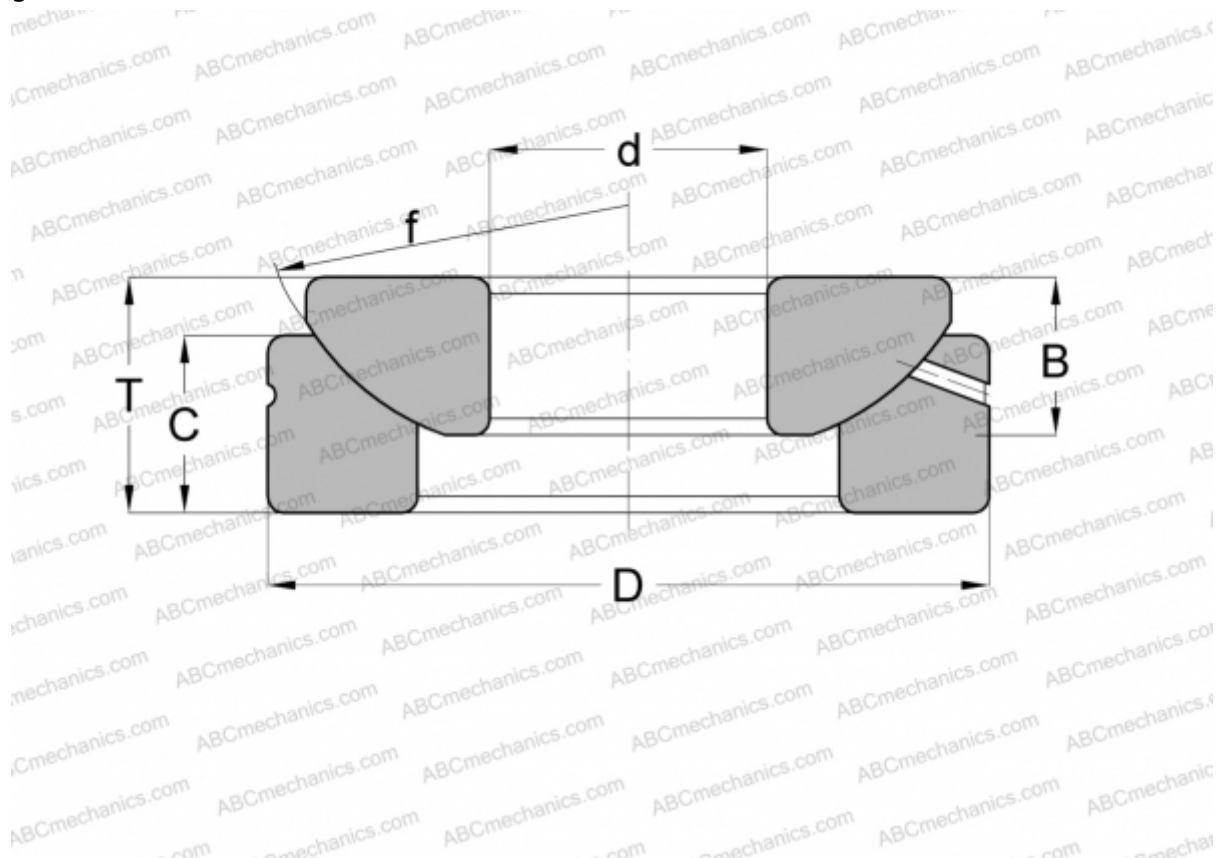

Technical specification

DIMENSIONS, MM

d	70,000
D	160,000
B	42,000
f	176,000
T	50,000
C	36,500

WEIGHT, KG 5,370

MANUFACTURER [FLURO](#)