

GE 120 AX FLURO

Spherical plain bearings

TYPE: Plain bearings, Spherical plain bearings and rod ends, Thrust spherical plain bearings,
Requiring maintenance, Series GE..-AX (FLURO)

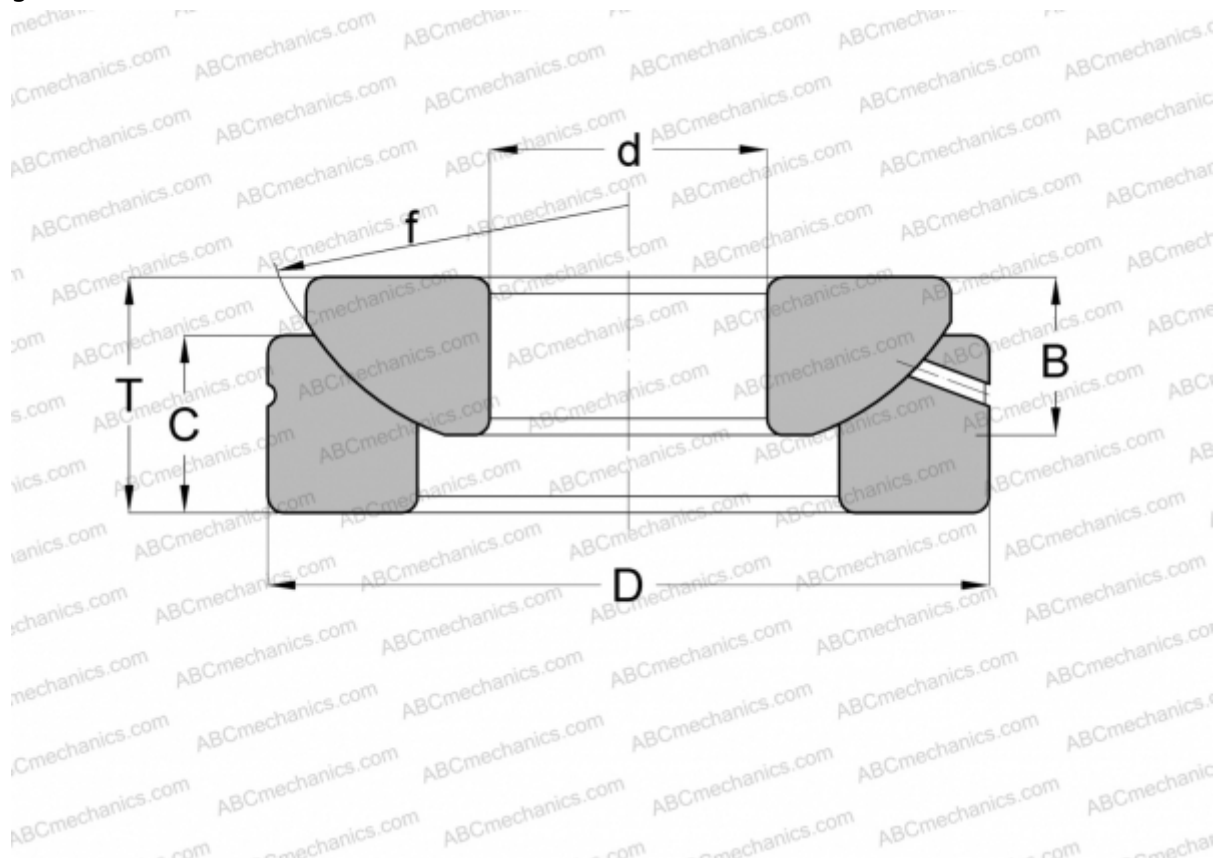

Technical specification

DIMENSIONS, MM

d	120,000
D	230,000
B	53,500
f	250,000
T	64,000
C	50,000

WEIGHT, KG 14,000

MANUFACTURER [FLURO](#)