

GE 180 AX FLURO

Spherical plain bearings

TYPE: Plain bearings, Spherical plain bearings and rod ends, Thrust spherical plain bearings,
Requiring maintenance, Series GE..-AX (FLURO)

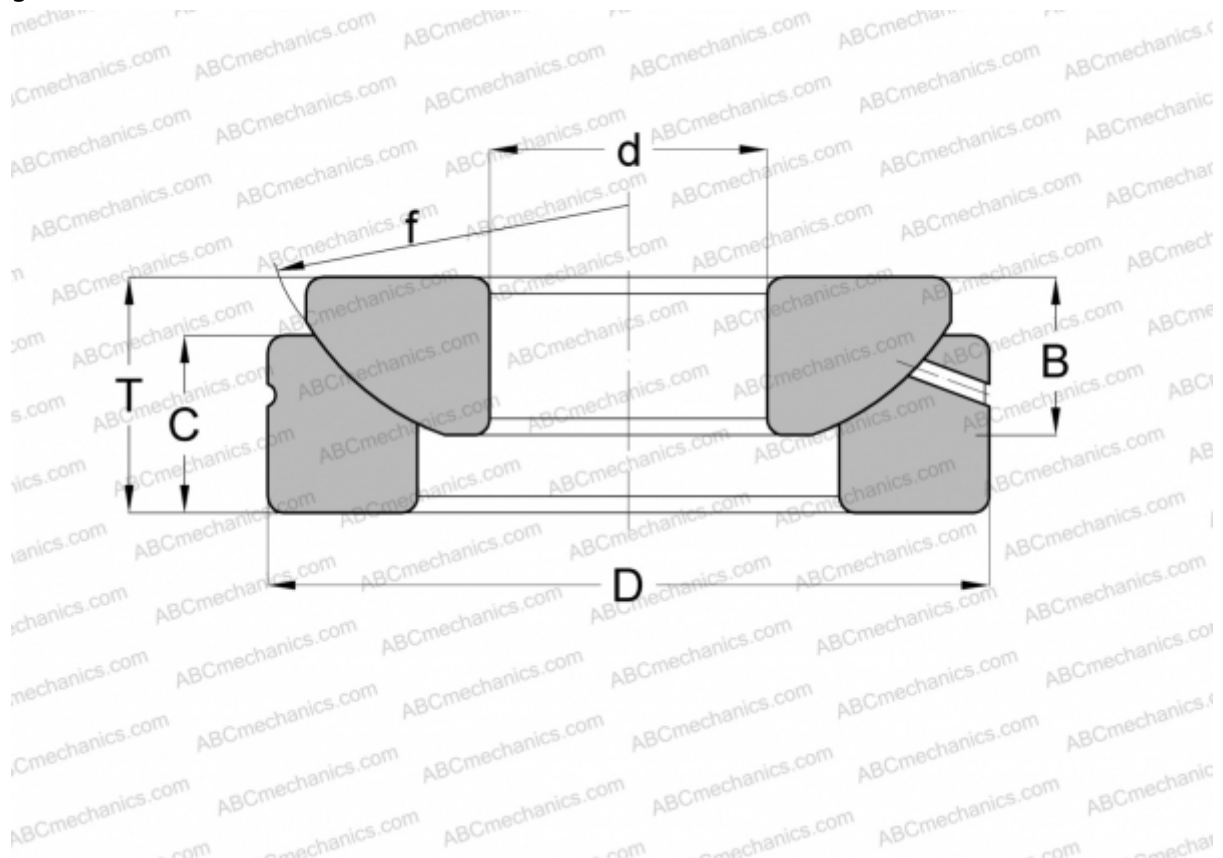

Technical specification

DIMENSIONS, MM

d	180,000
D	320,000
B	74,000
f	340,000
T	86,000
C	62,000

WEIGHT, KG 32,800

MANUFACTURER [FLURO](#)