

GE 200 AX FLURO

Spherical plain bearings

TYPE: Plain bearings, Spherical plain bearings and rod ends, Thrust spherical plain bearings,
Requiring maintenance, Series GE..-AX (FLURO)

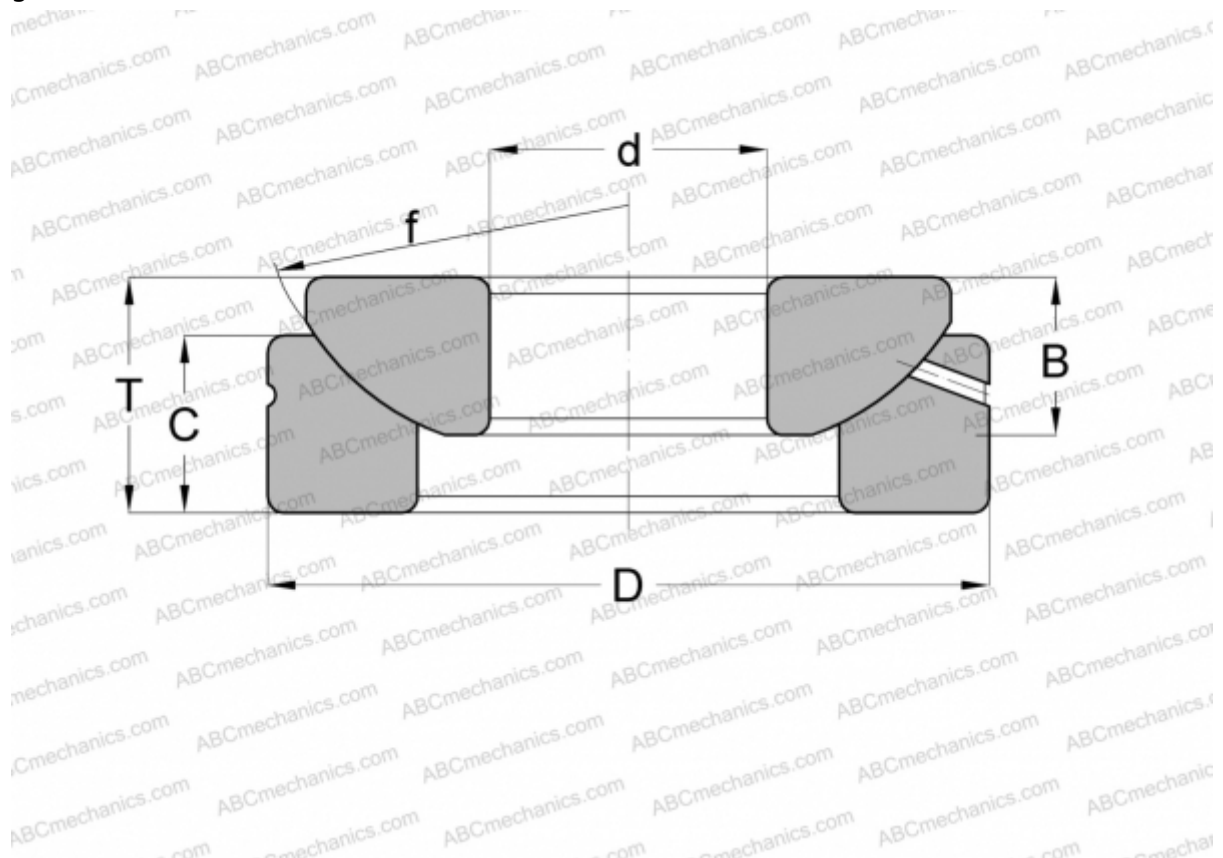

Technical specification

DIMENSIONS, MM

d	200,000
D	340,000
B	80,000
f	365,000
T	87,000
C	66,000

WEIGHT, KG 35,400

MANUFACTURER [FLURO](#)