

## GIR 10 UK ELGES

TYPE: Plain bearings, Spherical plain bearings and rod ends, Rod ends, Maintenance free, With internal thread, open design, right hand thread, series GIR.-UK (INA)

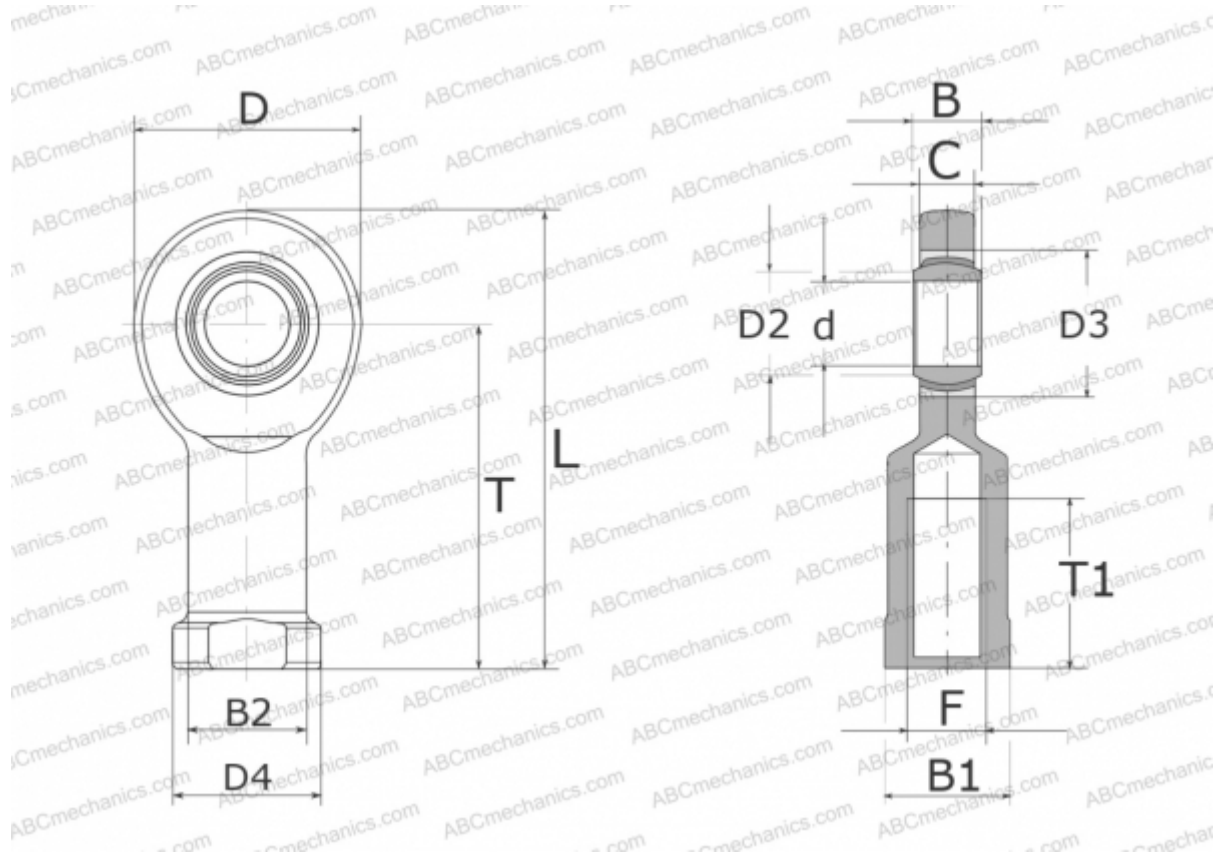

### Technical specification

#### DIMENSIONS, MM

d	10,000
D	29,000
D2	13,200
D3	19,000
D4	19,000
B	9,000
B1	17,000
B2	15,000
L	57,500
T	43,000
T1	20,000
C	7,000
F	M10

#### MANUFACTURER

[ELGES](#)

#### WEIGHT, KG

0,066