

GIR50-UK-2RS ELGES

TYPE: Plain bearings, Spherical plain bearings and rod ends, Rod ends, Maintenance free, With internal thread, with lip seals or high performance seals, right hand thread, series GIR..-UK-2RS (INA)

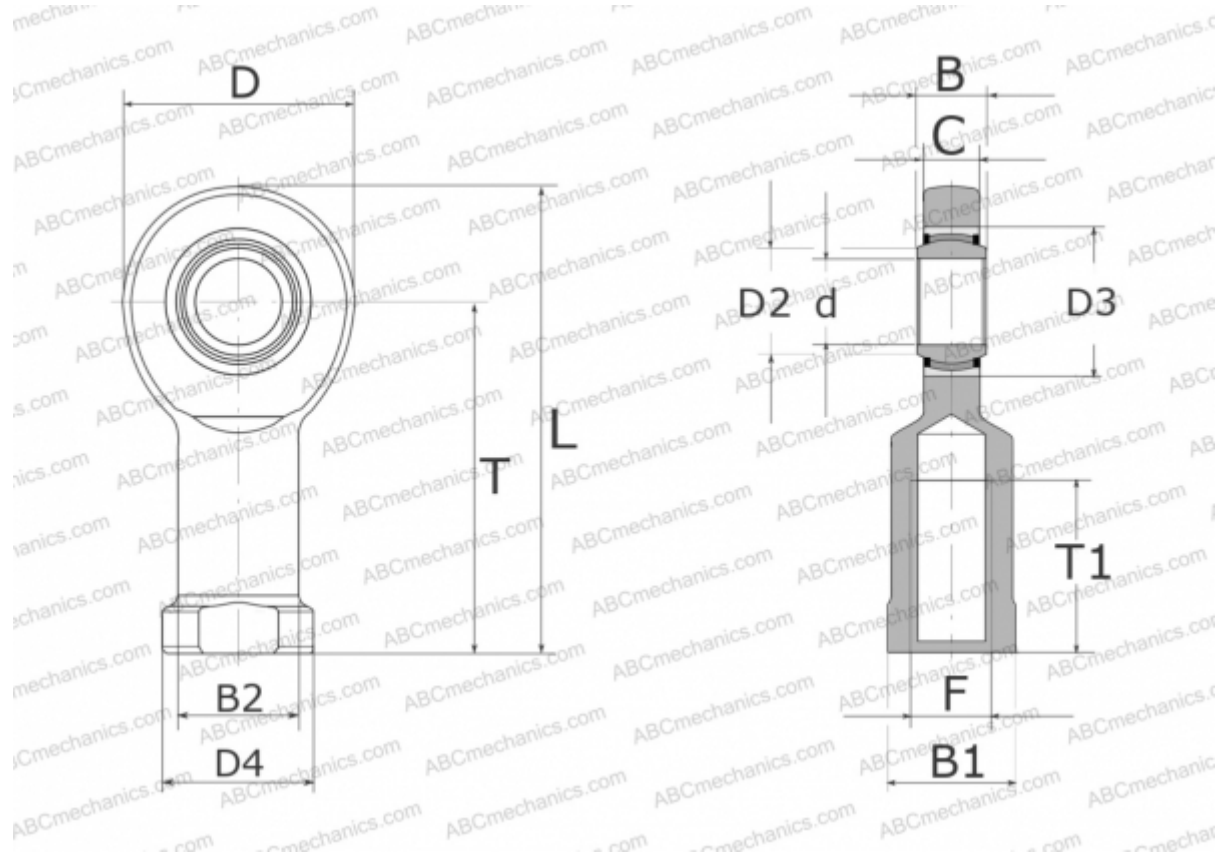

Technical specification

DIMENSIONS, MM

d	50,000
D	112,000
D2	56,000
D3	75,000
D4	75,000
B	35,000
B1	65,000
B2	62,000
L	216,000
T	160,000
T1	68,000
C	30,000
F	M45X3

MANUFACTURER

[ELGES](#)

WEIGHT, KG

3,540