

GIL15-UK ELGES

TYPE: Plain bearings, Spherical plain bearings and rod ends, Rod ends, Maintenance free, With internal thread, open design, left hand thread, series GIL..-UK (INA)

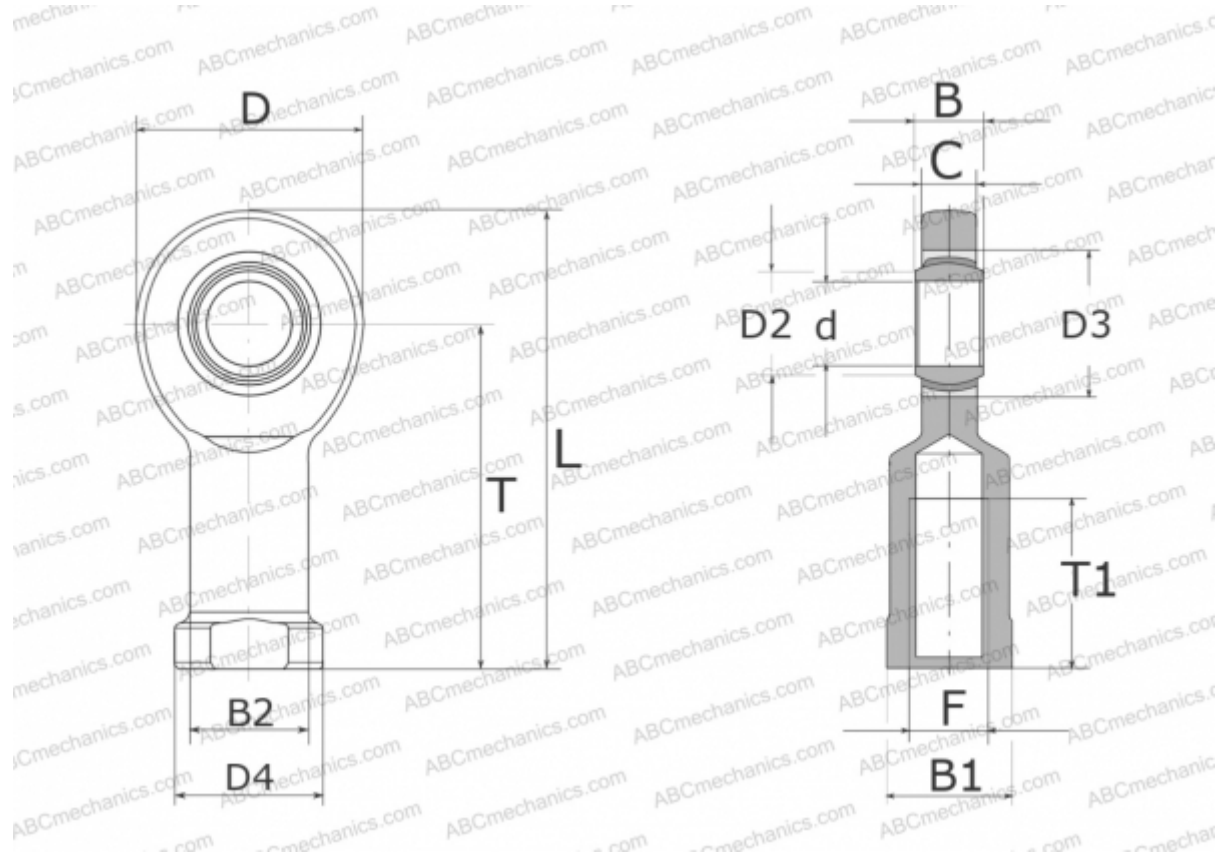

Technical specification

DIMENSIONS, MM

d	15,000
D	40,000
D2	18,400
D3	26,000
D4	26,000
B	12,000
B1	22,000
B2	21,000
L	81,000
T	61,000
T1	30,000
C	10,000
F	M14

MANUFACTURER

[ELGES](#)

WEIGHT, KG

0,180