

GIL45-UK-2RS ELGES

TYPE: Plain bearings, Spherical plain bearings and rod ends, Rod ends, Maintenance free, With internal thread, with lip seals or high performance seals, left hand thread, series GIL.-UK-2RS (INA)

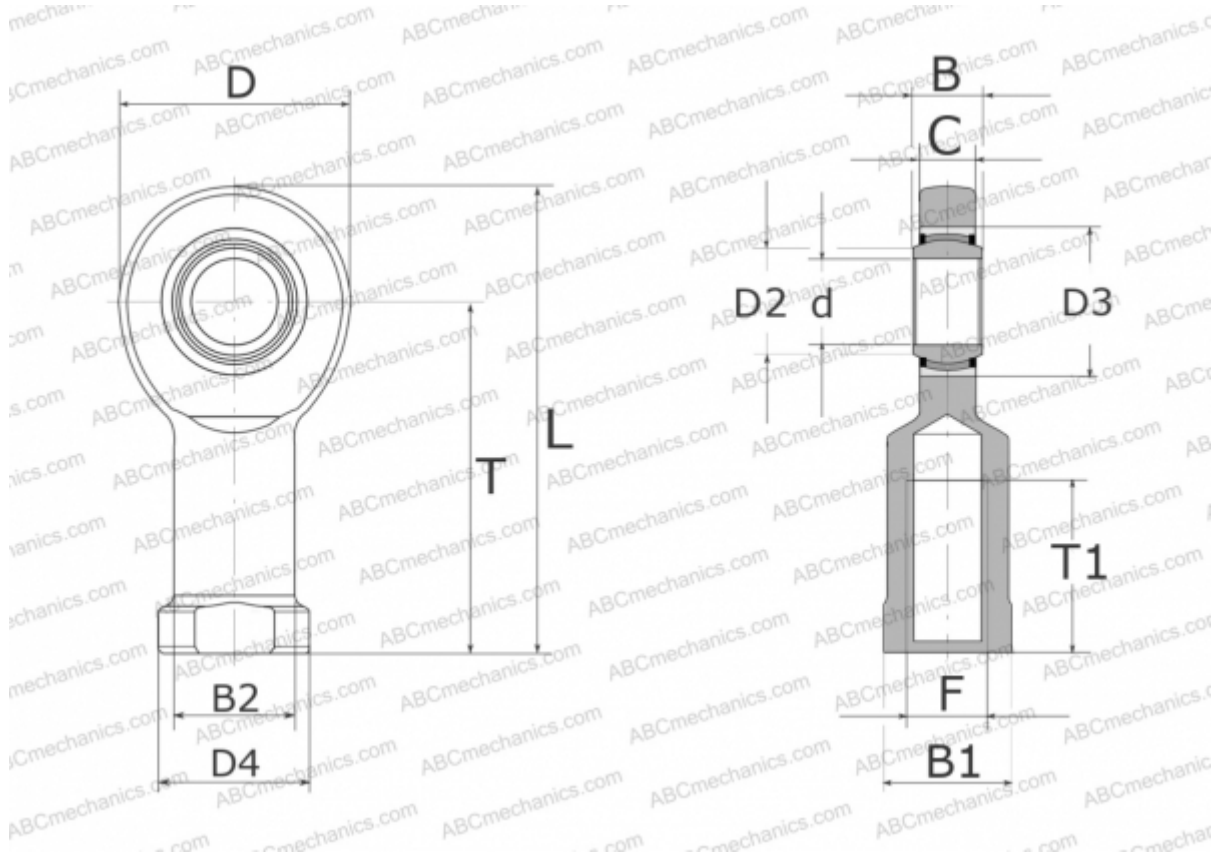

Technical specification

DIMENSIONS, MM

d	45,000
D	102,000
D2	50,800
D3	68,000
D4	70,000
B	32,000
B1	60,000
B2	58,000
L	196,000
T	145,000
T1	65,000
C	27,000
F	M42X3

MANUFACTURER

[ELGES](#)

WEIGHT, KG

2,700