

GAR25-UK-2RS ELGES

TYPE: Plain bearings, Spherical plain bearings and rod ends, Rod ends, Maintenance free, With external thread, with lip seals or high performance seals, right hand thread, series GAR..-UK-2RS (INA)

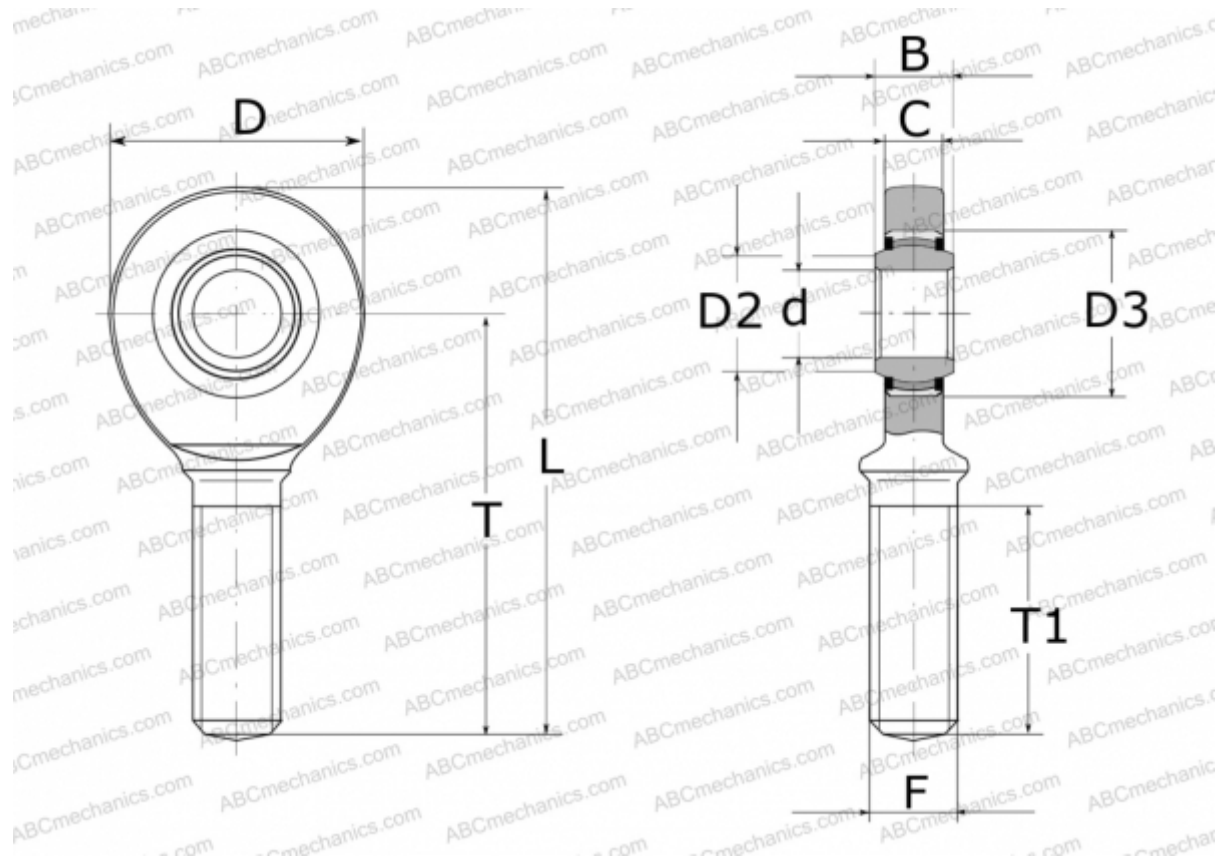

Technical specification

DIMENSIONS, MM

d	25,000
D	64,000
D2	29,300
D3	42,000
B	20,000
L	126,000
T	94,000
T1	53,000
C	17,000
F	M24X2

WEIGHT, KG 0,590

MANUFACTURER [ELGES](#)