

GAR30-UK-2RS ELGES

TYPE: Plain bearings, Spherical plain bearings and rod ends, Rod ends, Maintenance free, With external thread, with lip seals or high performance seals, right hand thread, series GAR..-UK-2RS (INA)

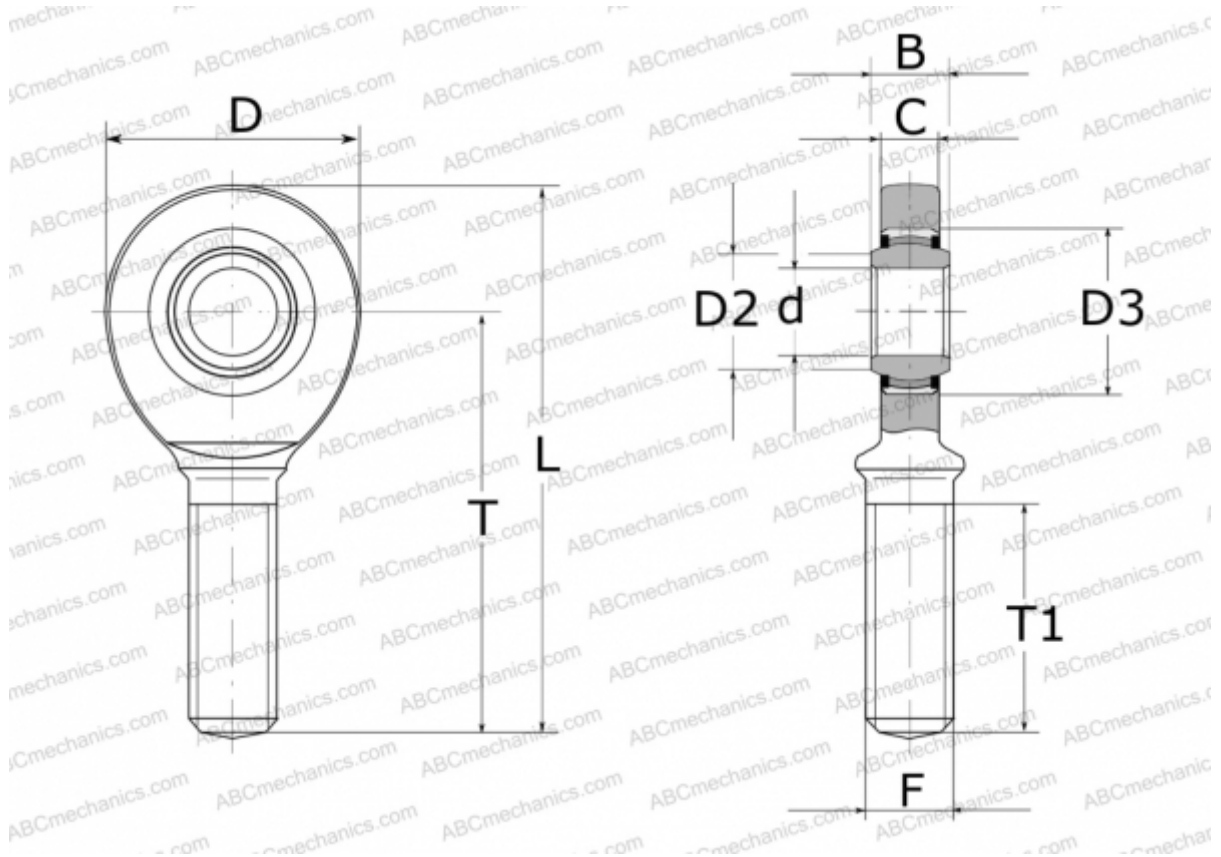

Technical specification

DIMENSIONS, MM

d	30,000
D	73,000
D2	34,200
D3	47,000
B	22,000
L	146,500
T	110,000
T1	65,000
C	19,000
F	M30X2

WEIGHT, KG 0,930

MANUFACTURER [ELGES](#)