

## GAL25-UK ELGES

TYPE: Plain bearings, Spherical plain bearings and rod ends, Rod ends, Maintenance free, With external thread, open design, left hand thread, series GAL.-UK (INA)

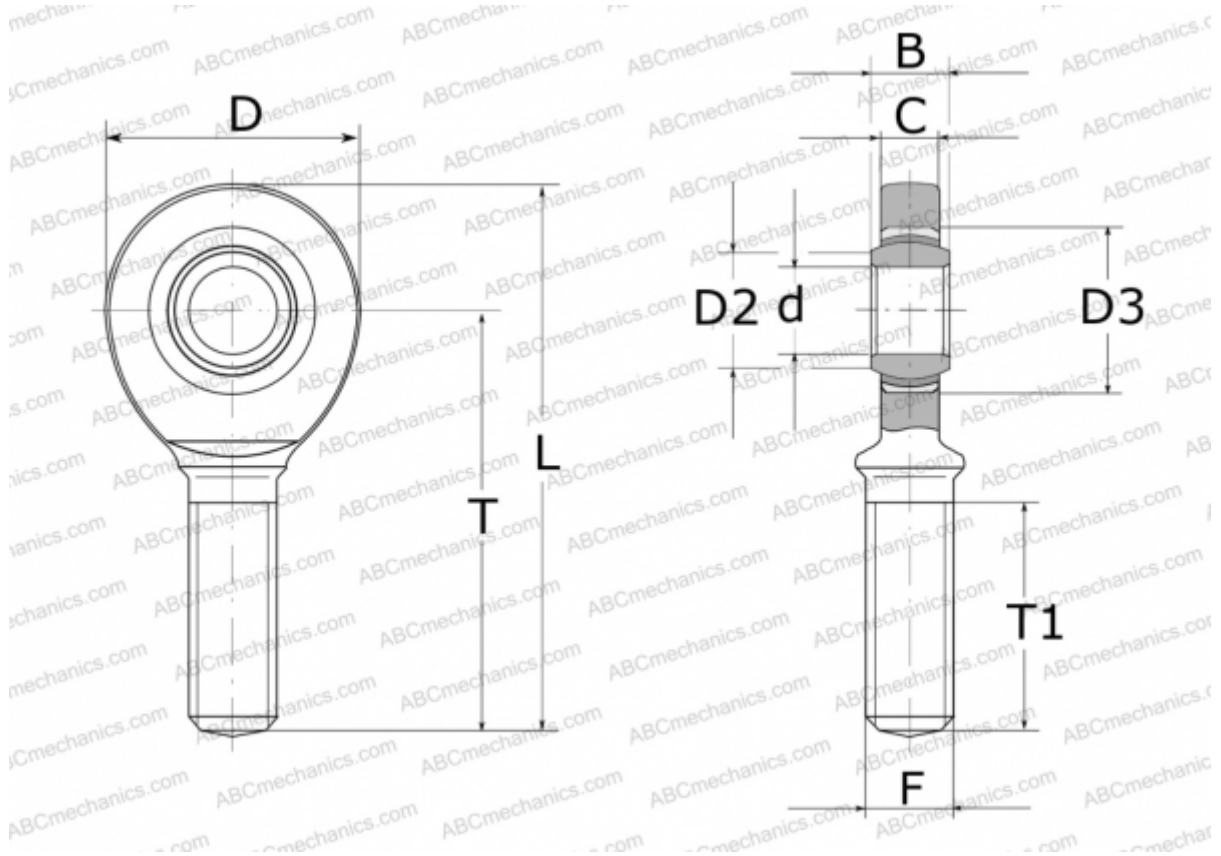

### Technical specification

#### DIMENSIONS, MM

d	25,000
D	64,000
D2	29,300
D3	42,000
B	20,000
L	126,000
T	94,000
T1	53,000
C	17,000
F	M24X2

**WEIGHT, KG** 0,600

**MANUFACTURER** [ELGES](#)