

## GAKSR5-PS ELGES

TYPE: Plain bearings, Spherical plain bearings and rod ends, Rod ends, Maintenance free, With external thread, open design, right hand thread, corrosion-resistant, series GAKSR..-PS (INA)

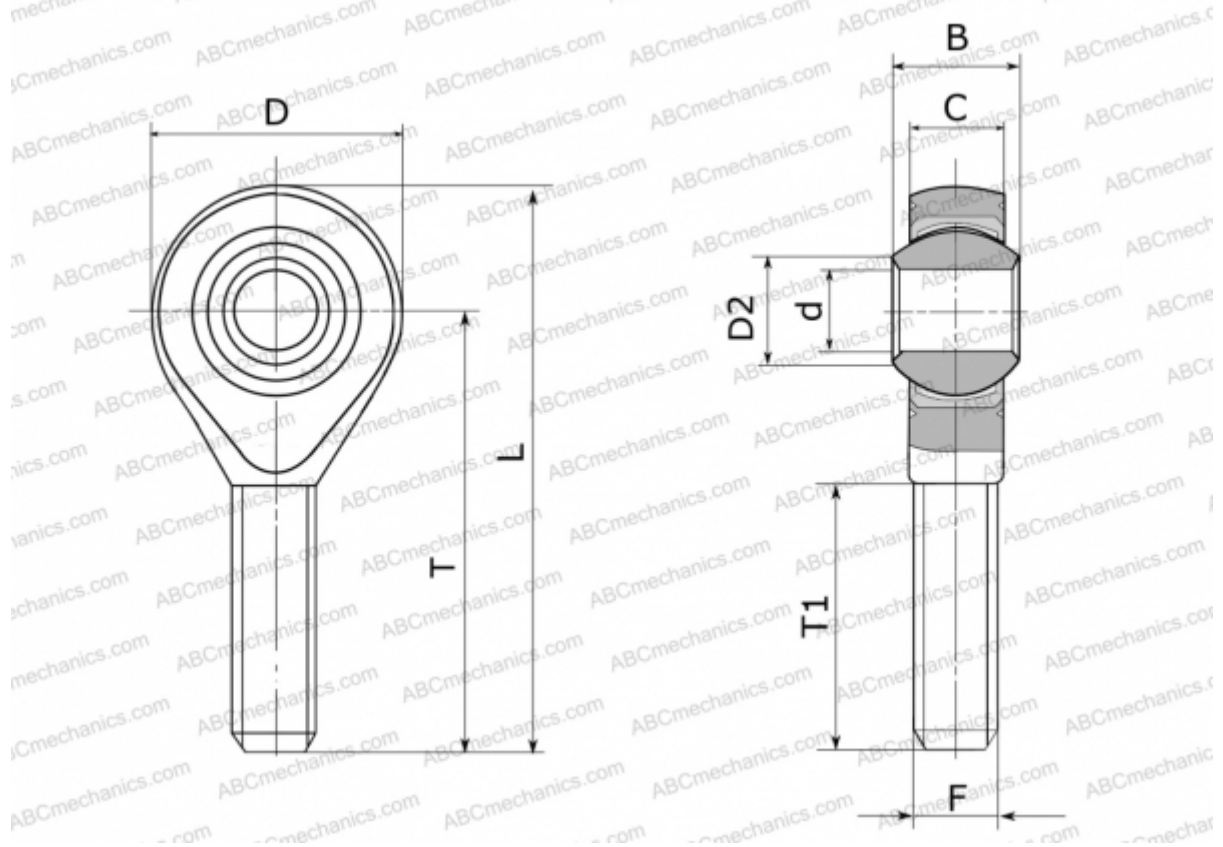

### Technical specification

#### DIMENSIONS, MM

d	5,000
D	19,000
D2	7,700
B	8,000
L	42,500
T	33,000
T1	19,000
C	6,000
F	M5

**WEIGHT, KG** 0,010

**MANUFACTURER** [ELGES](#)