

GIKSR18-PS ELGES

TYPE: Plain bearings, Spherical plain bearings and rod ends, Rod ends, Maintenance free, With internal thread, corrosion-resistant, open design, right hand thread, series GIKSR.-PS, GIKPSR.-PS (INA)

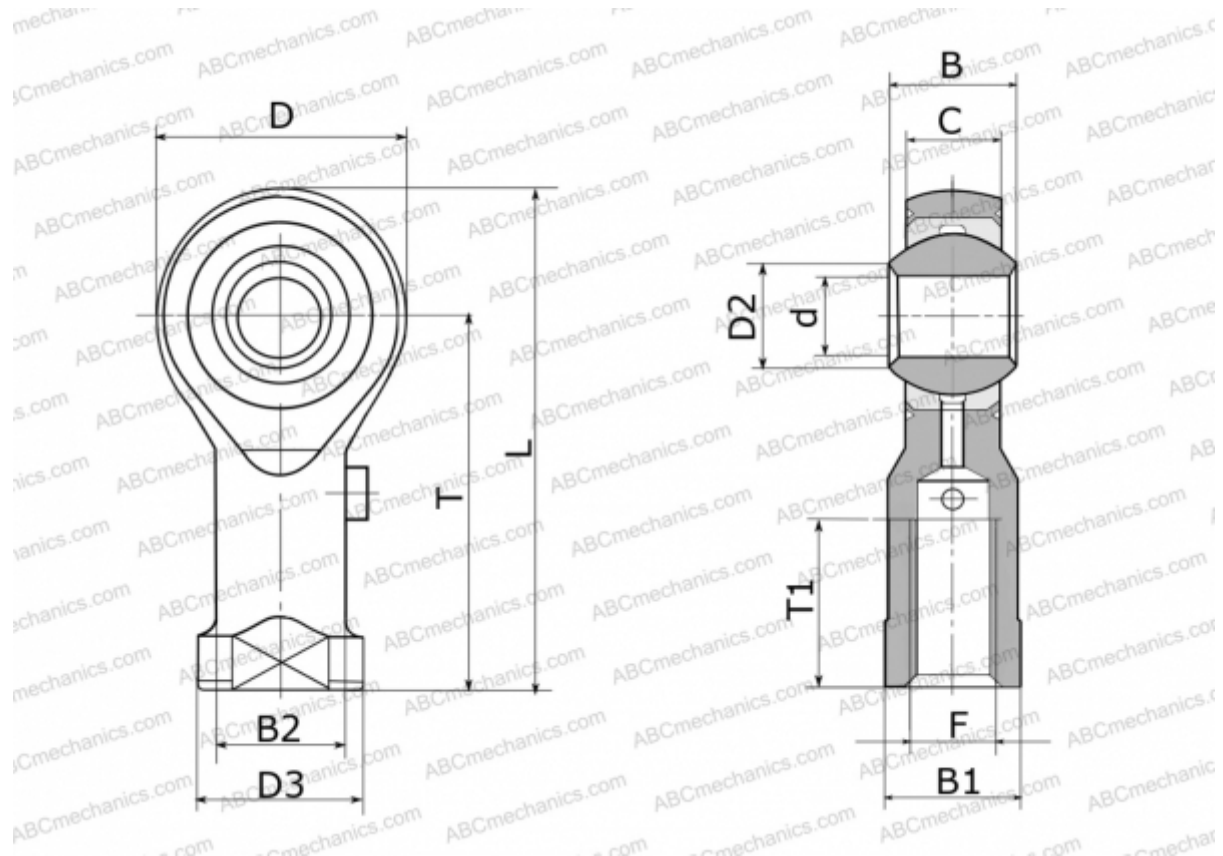

Technical specification

DIMENSIONS, MM

d	18,000
D	47,000
D2	21,900
D3	31,000
B	23,000
B1	27,000
B2	25,000
L	94,500
T	71,000
T1	27,000
C	16,500
F	M18X1.5

MANUFACTURER

[ELGES](#)

WEIGHT, KG

0,300