

## GIKSL5-PS ELGES

TYPE: Plain bearings, Spherical plain bearings and rod ends, Rod ends, Maintenance free, With internal thread, corrosion-resistant, open design, left hand thread, series GIKSL..-PS, GIKPSL..-PS (INA)

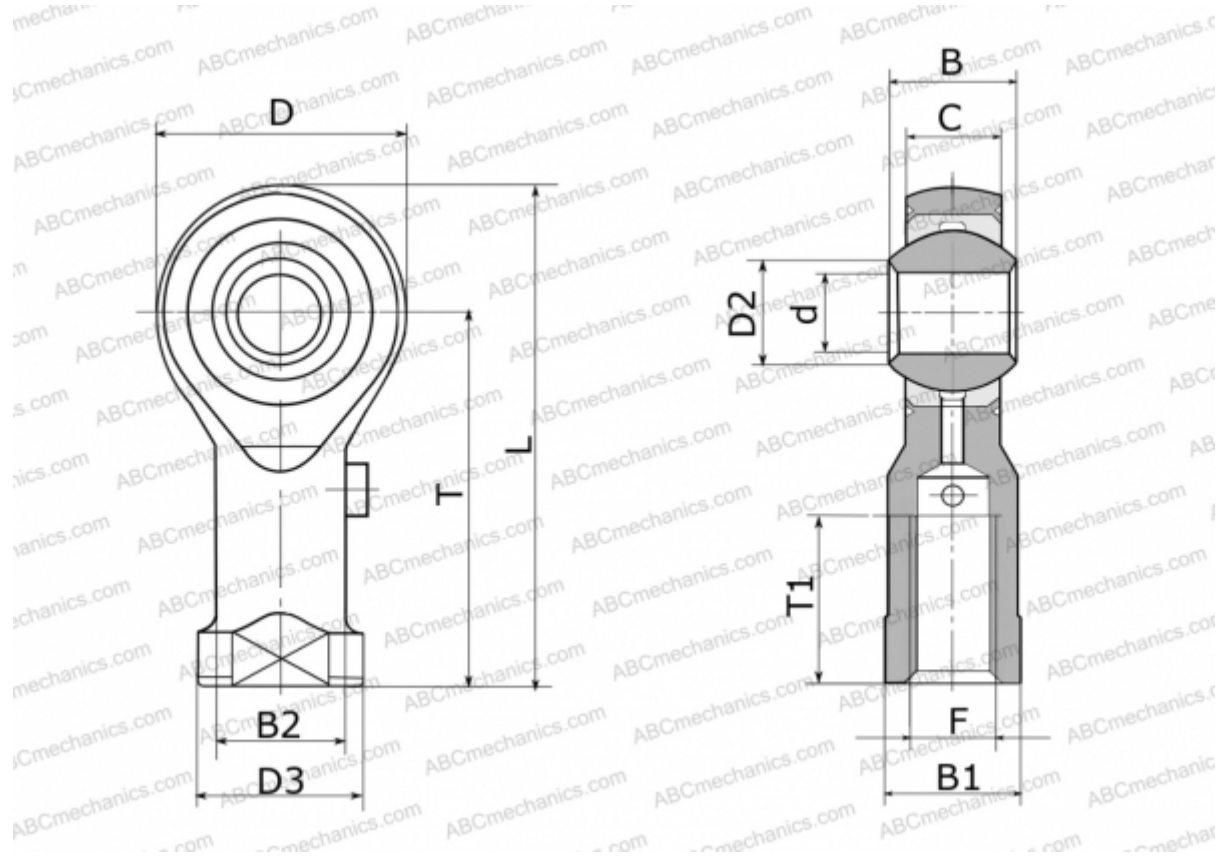

### Technical specification

#### DIMENSIONS, MM

d	5,000
D	19,000
D2	7,700
D3	11,000
B	8,000
B1	9,000
B2	9,000
L	36,500
T	27,000
T1	8,000
C	6,000
F	M5

#### MANUFACTURER

[ELGES](#)

#### WEIGHT, KG

0,017