

GASW 25 FLURO

TYPE: Plain bearings, Spherical plain bearings and rod ends, Rod ends, Maintenance free, With external thread, open design, right hand thread, series GASW (FLURO)

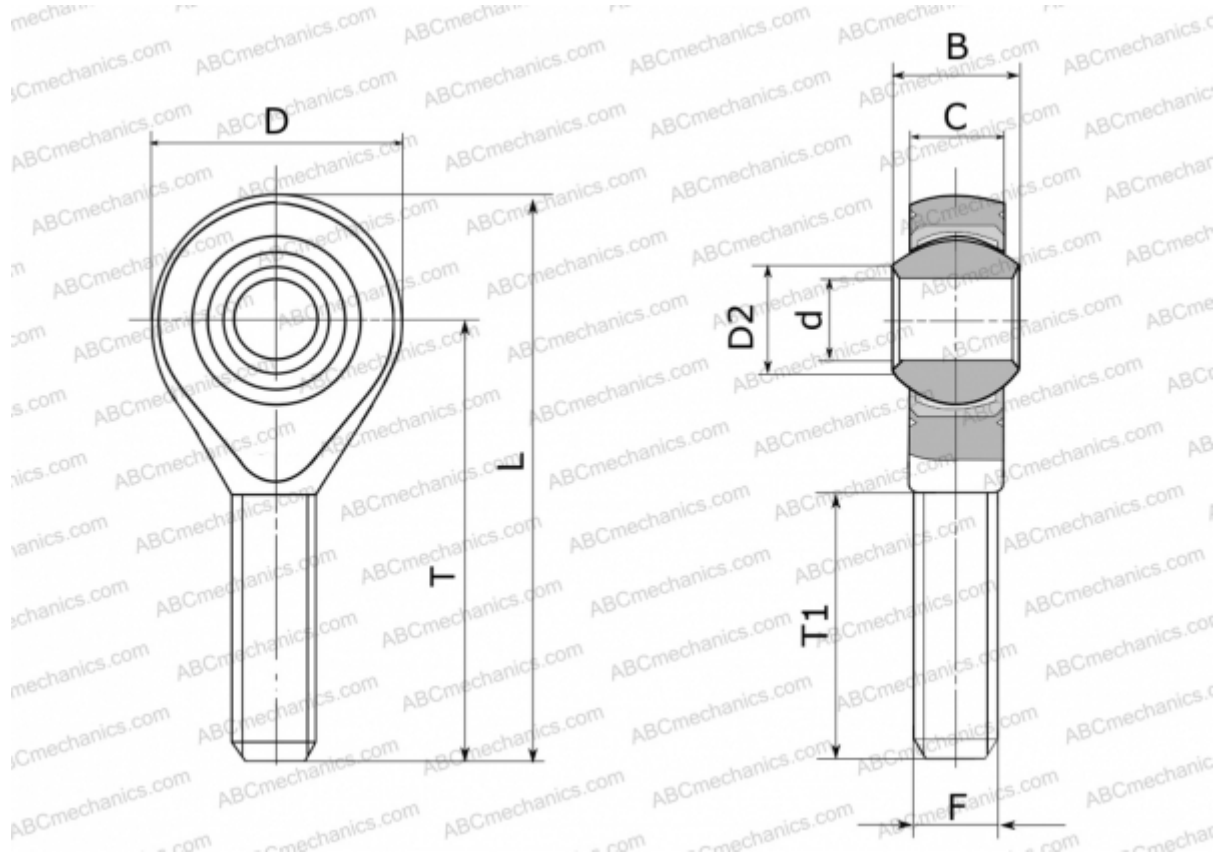

Technical specification

DIMENSIONS, MM

d	25,000
D	60,000
D2	29,600
B	31,000
L	124,000
T	94,000
T1	57,000
C	22,000
F	M 24x2

WEIGHT, KG 0,600

MANUFACTURER [FLURO](#)