

GASW 50 FLURO

TYPE: Plain bearings, Spherical plain bearings and rod ends, Rod ends, Maintenance free, With external thread, open design, right hand thread, series GASW (FLURO)

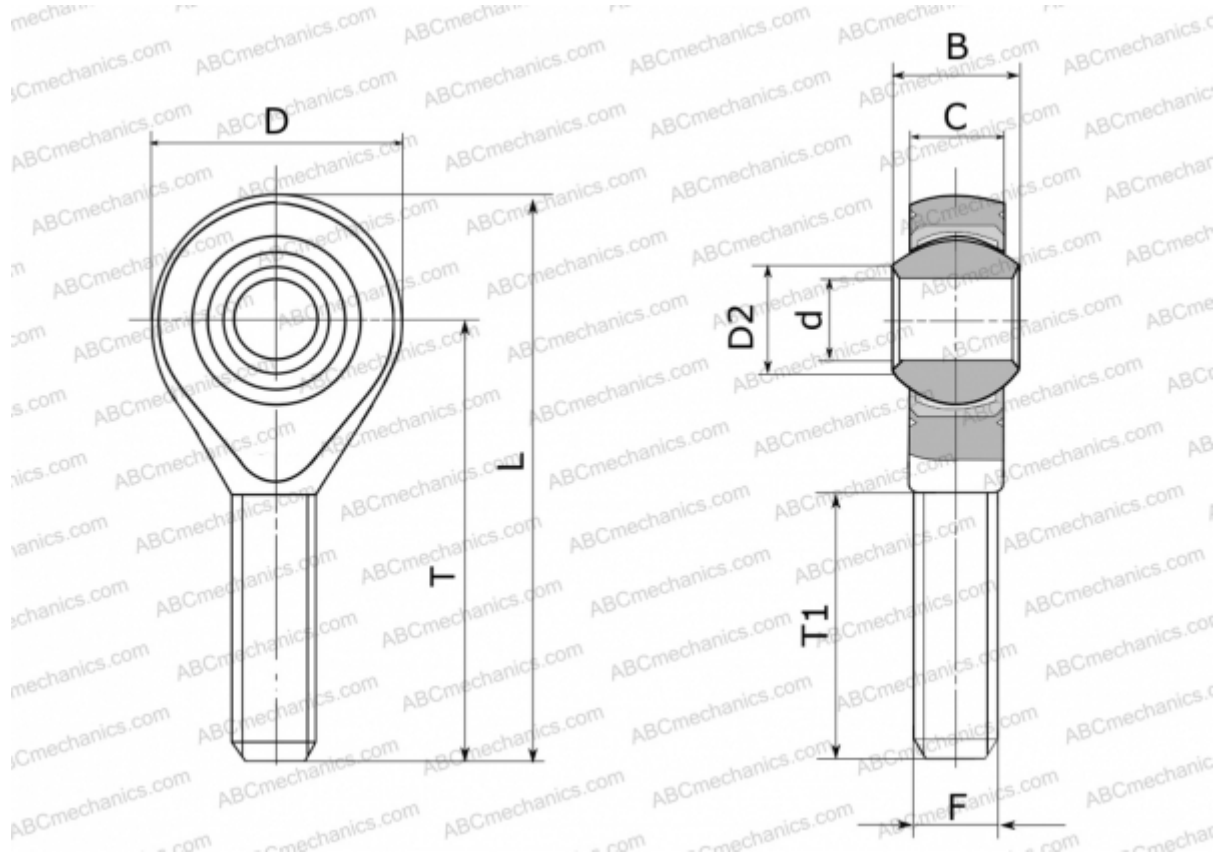

Technical specification

DIMENSIONS, MM

d	50,000
D	116,000
D2	55,900
B	60,000
L	243,000
T	185,000
T1	105,000
C	45,000
F	M 48x2

WEIGHT, KG 4,800

MANUFACTURER [FLURO](#)